

CE UK
CA

FUSION

Large 4 Digit Process Signal Display



Model FUSION-P

Installation & Operating Manual Revision 27

- ✓ Easy setup
- ✓ Fully scalable
- ✓ 24V sensor scalable
- ✓ 10 point linearisation
- ✓ Optional Output 4-20mA / 0-10V isolated
- ✓ Optional Alarm output = 2 or 4 relays
- ✓ Optional Comms Output = RS232 or RS485
- ✓ 95-230V AC or 11-30V DC power

Caution: There is a risk of electrical shock if this instrument is not properly installed



Caution: Risk of danger: Read the whole manual before you install this meter



**London
Electronics
Limited**

www.london-electronics.com

Table of Contents

Warranty 1

Warnings 2

Introduction..... 3

General Description 4

Suspension Mounting Dimensions..... 5

Wall Mounting Dimensions..... 6

Panel Mounting Dimensions 7

Connections..... 8

Connections..... 9

Installation Hints For Best Performance 10

48V AC Power Wiring Option 12

Display Brightness 13

Meter Calibration Modes..... 14

Direct Calibration - Full Scale Setting 15

Direct Calibration - Zero Setting 16

Linearisation with Direct Calibration..... 17

Linearisation with Direct Calibration - Continued..... 18

Theoretical Calibration - Decimal Point & Full Scale 19

Theoretical Calibration - Low End Calibration..... 20

Linearisation with Theoretical Calibration..... 21

Linearisation with Theoretical Calibration - Cont'd. 22

Sensor Drift Correction..... 23

Logic Input Functions 24

Logic Input Connections & Front Buttons 25

Factory Defaults 26

Calibration Audit Number26

Signal Filtering / Averaging27

Signal Filtering / Averaging28

Last Digit Rounding Up By 1, 2, 5, 10, 20 or 5029

Scale Factor Adjustment30

Offset Adjustment.....31

Menu Timeout Adjustment.....32

Reverse Display Function (Mirror Image)33

Bootup Routine & Tare Save Choices34

Multi-Program Memory Option ‘MEM’35

Error Codes & Fault Findings.....36

How To Install Option Boards37

Waste Electrical Electronic Equipment (WEEE)38

Equipment Specifications.....39

Record of Revisions.....40

Declaration of UK & CE Conformity.....41

Warranty

We warrant this product against defects in materials or workmanship for a period of three (3) years from the date of purchase.

In the event of a defect during the warranty period, the unit should be returned, freight (and all duties and taxes) prepaid by the Buyer to the authorised distributor from where the unit was purchased.

The Distributor, at its option, will repair or replace the defective unit. The unit will be returned to the Buyer with freight charges prepaid by the distributor.

LIMITATION OF WARRANTY

The foregoing warranty shall not apply to defects resulting from:

1. Improper or inadequate maintenance by the buyer.
2. Unauthorised modification or misuse.
3. Operation outside the environmental specification of the product.
4. Mishandling or abuse.

The warranty set forth above is exclusive and no other warranty, whether written or oral is expressed or implied. We specifically disclaim the implied warranties of merchantability and fitness for a particular purpose.

EXCLUSIVE REMEDIES

The remedies provided herein are the buyer's sole and exclusive remedies.

In no event shall we be liable for direct, indirect, incidental or consequential damages (including loss of profits) whether based on contract, tort or any other legal theory.

Warnings

Please carefully read this manual and all warnings. Install the meter ONLY when you are sure that you've covered all aspects.



Where the product is intended for "UL" installations, removal or addition of option boards is not permitted.



Check that the model number and supply voltage suit your application before you install the meter.



Connect the meter according to current IEE regulations, IEC61010 & NFPA:70 National Electric Code in USA.



Power supplies to this equipment must have anti-surge (T) fuses rated at 400mA for 230V supply, 400mA for 110V supply or 2A for DC supplies in the range 11-30VDC.



Don't touch any circuitry after you have connected the meter, because there may be lethal voltages on the circuit board.



Do not apply power to the display if its case is open.



Only adjust on-board switches or connections with the power turned off.



Make sure all screw terminals are tight before you switch the meter on.



Only clean the meter's front with a soft damp cloth. Only lightly dampen with water. Do not use any other solvents.

Rear case screws - please note

The rear panel is held in place with socket flange button head screws, which only need to be gently tightened, with the supplied 2mm hex key.

Do not use tools to tighten or loosen the screws, as this could cause damage to the internal threads.

Introduction

Please contact us if you need help, if you have a complaint, or if you have suggestions to help us improve our products or services.

If you contact us about a product you already have, please tell us the full model number and serial number, so that we can give you accurate and fast help.

This product has a 3 year warranty. We will put right or replace any meter which is faulty because of bad workmanship or materials.

This warranty does not cover damage caused by misuse or accident. If you return a unit for repair, you must fill in the RMA form on our website, please include a detailed description of the problem, and the name of a contact who we can refer to for any questions. Please mark for the attention of the QA Department.

We always try to improve our products and services, so these may change over time. You should keep this manual safely, because future manuals, for new designs, may not describe this product accurately.

We believe these instructions are accurate, and that we have competently designed and manufactured the product, but please let us know if you find any errors.

General Description

This series of meters accepts industrial sensors to allow various physical measurements to be made, such a weight, temperature, pressure, humidity etc. Different models are available for different sensor types.

The main function of this series is to give a numeric readout of the variable being monitored. Most models include an excitation power output, to power the sensor directly.

Various digit heights are available, to suit the maximum viewing distance required in each installation.

Various optional output modules are also available to give alarm relay outputs, analogue output or digital communications, or any combination of these options.

Displays are programmed using front panel push buttons. The front panel buttons can be disabled. In addition, you can connect 4 remote wired push buttons to the display, so that you can make adjustments while the display is mounted in an inaccessible location.

Power supply options : 95-265V AC, 48V AC or 11-30VDC

These displays must be installed fully assembled, and must be installed according to local electrical installation rules.

When properly installed, and provided they have been ordered with cable glands exiting the lower surface of the case, they provide ingress protection to IP65 / NEMA4X from all directions.

Safety



Caution: There is a risk of electrical shock if this instrument is not properly installed



Caution: Risk of danger: Read the whole manual before you install this meter

Obey all safety warnings in this manual, and install the meter according to local wiring and installation regulations. Failure to follow these guidelines may cause damage to the meter, connected equipment, or may be harmful to personnel.

Any moving mechanical device controlled by this equipment must have suitable access guards to prevent injury to personnel if the meter should fail.

Suspension Mounting Dimensions

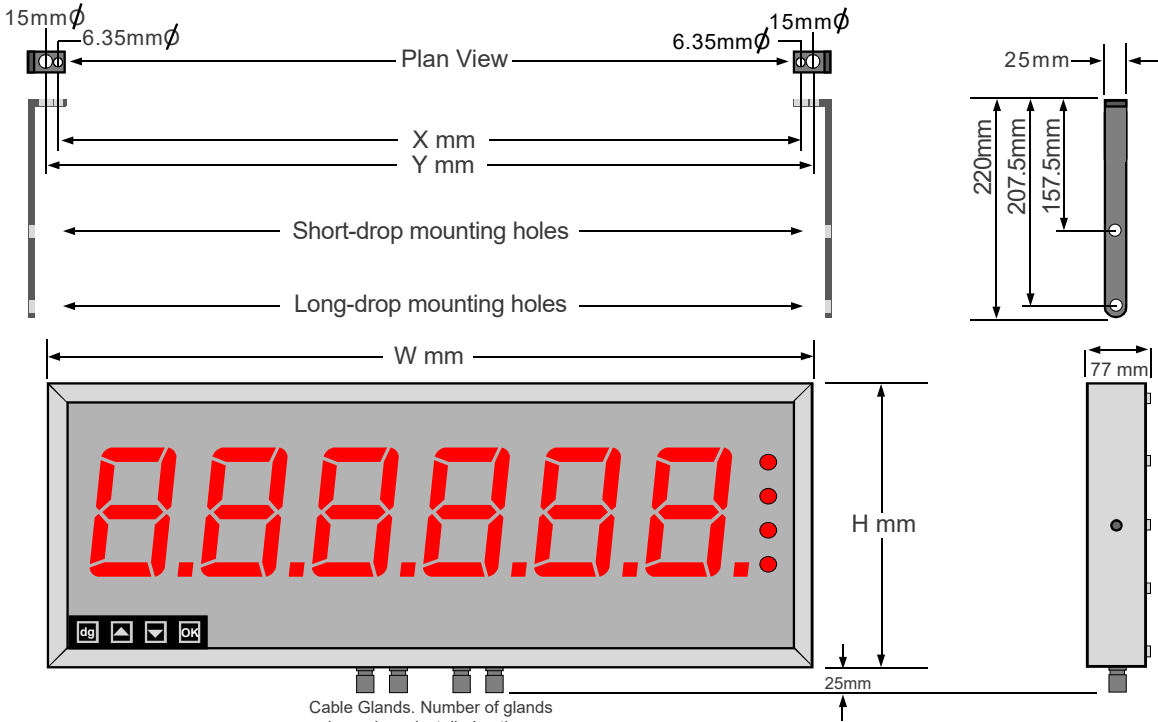

Detail showing bracket hardware fitting sequence

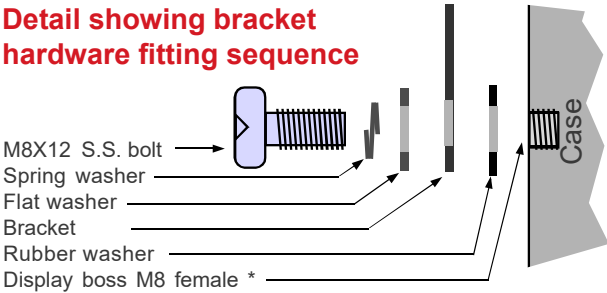

You can order these displays with the cable glands in the bottom surface (as shown) the rear, or top.

Rear glands allow you to mount the display on top of a cubicle, using the brackets shown.

*** Do not use longer bolt threads than 12mm , or you will fracture the female boss and the case will no longer be sealed.**

Display Format	X mm	H mm	W mm	Y mm
2" 4 digit numeric	219.5	154.5	279.5	249.5
2" 6 digit numeric	316	154.5	376	346
4" 4 digit numeric	374	195.5	434	404
4" 6 digit numeric	556	195.5	616	586
6" 4 digit	520	246	580	550
6" 6 digit	760	246	820	790
8" 4 digit	690	290	750	720
8" 6 digit	1012	290	1072	1042
12" 4 digit	990	408	1050	1020
12" 6 digit	1480	408	1540	1510
16" 4 digit	1308	515	1368	1338
16" 6 digit	1960	515	2020	1990

Wall Mounting Dimensions

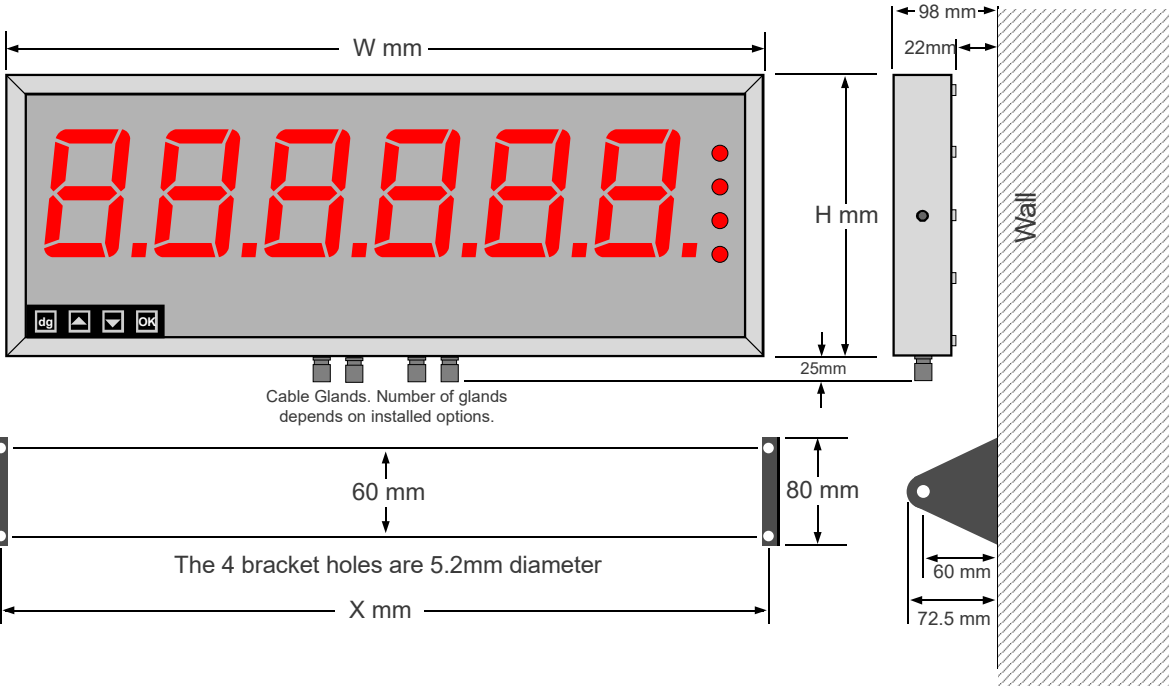

Detail showing bracket hardware fitting sequence

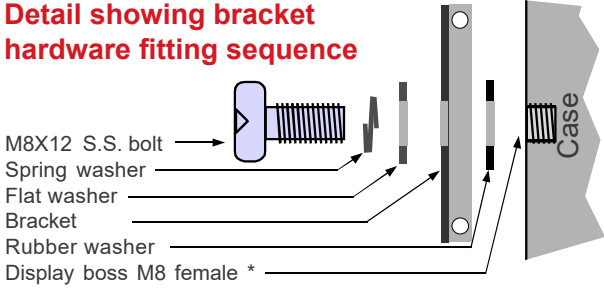

You can order these displays with the cable glands in the bottom surface (as shown) the rear, or top.

Rear glands allow you to mount the display on top of a cubicle, using the brackets shown.

*** Do not use longer bolt threads than 12mm , or you will fracture the female boss and the case will no longer be sealed.**

Display Format	X mm	H mm	W mm
2" 4 digit numeric	266.5	154.5	279.5
2" 6 digit numeric	363	154.5	376
4" 4 digit numeric	421	195.5	434
4" 6 digit numeric	603	195.5	616
6" 4 digit	567	246	580
6" 6 digit	807	246	820
8" 4 digit	737	290	750
8" 6 digit	1059	290	1072
12" 4 digit	1037	408	1050
12" 6 digit	1527	408	1540
16" 4 digit	1355	515	1368
16" 6 digit	2007	515	2020

Panel Mounting Dimensions

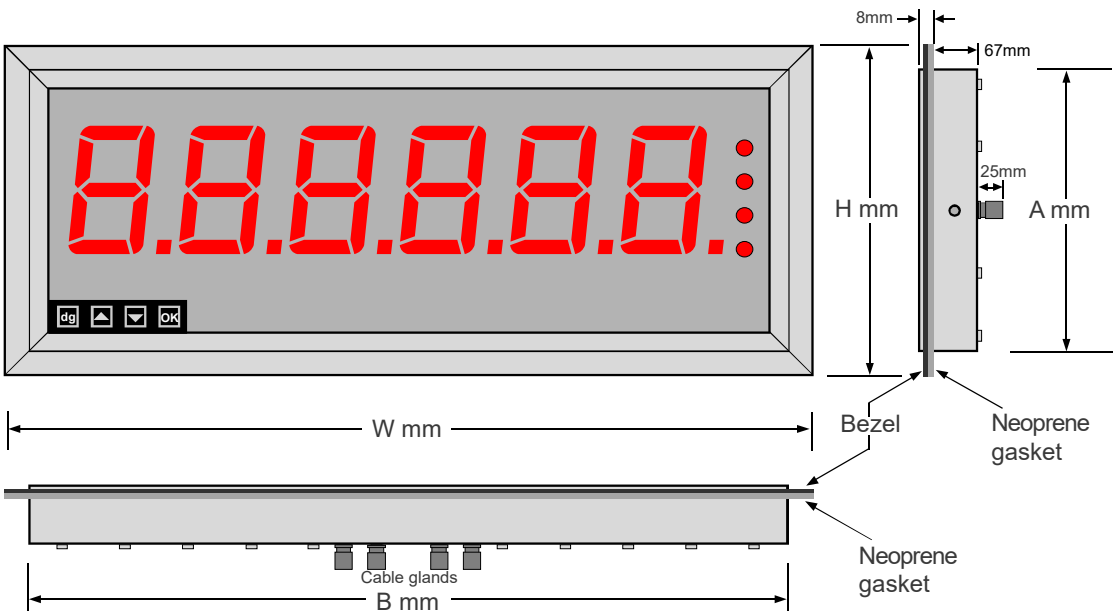

Detail showing bracket hardware fitting sequence

Panel cutout dimensions
 $A+3\text{mm}(h) \times B+3\text{mm}(w)$

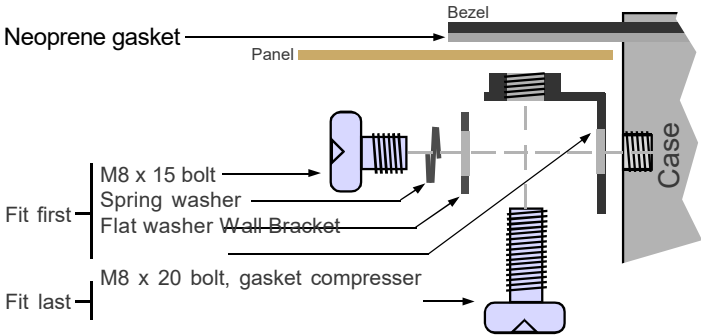

Display Format	H mm	A mm	B mm	Wmm
2" 4 digit numeric	172.5	154.5	279.5	297.5
2" 6 digit numeric	172.5	154.5	376	394
4" 4 digit numeric	213.5	195.5	434	452
4" 6 digit numeric	213.5	195.5	616	634
6" 4 digit	264	246	580	598
6" 6 digit	264	246	820	838
8" 4 digit	308	290	750	768
8" 6 digit	308	290	1072	1090
12" 4 digit	426	408	1050	1068
12" 6 digit	426	408	1540	1558
16" 4 digit	533	515	1368	1386
16" 6 digit	533	515	2020	2038

Connections



Warning:
Disconnect all power before removing the rear of the display

There is a wide range of possible locations for the input board, output board and power supply board/s. Their locations depend on the height of digits, number of digits, brightness of digits and any installed options. Because the permutation of possible locations is large, we will not describe the location of boards within the display, but simply identify the connectors and their functions on each board, below ...

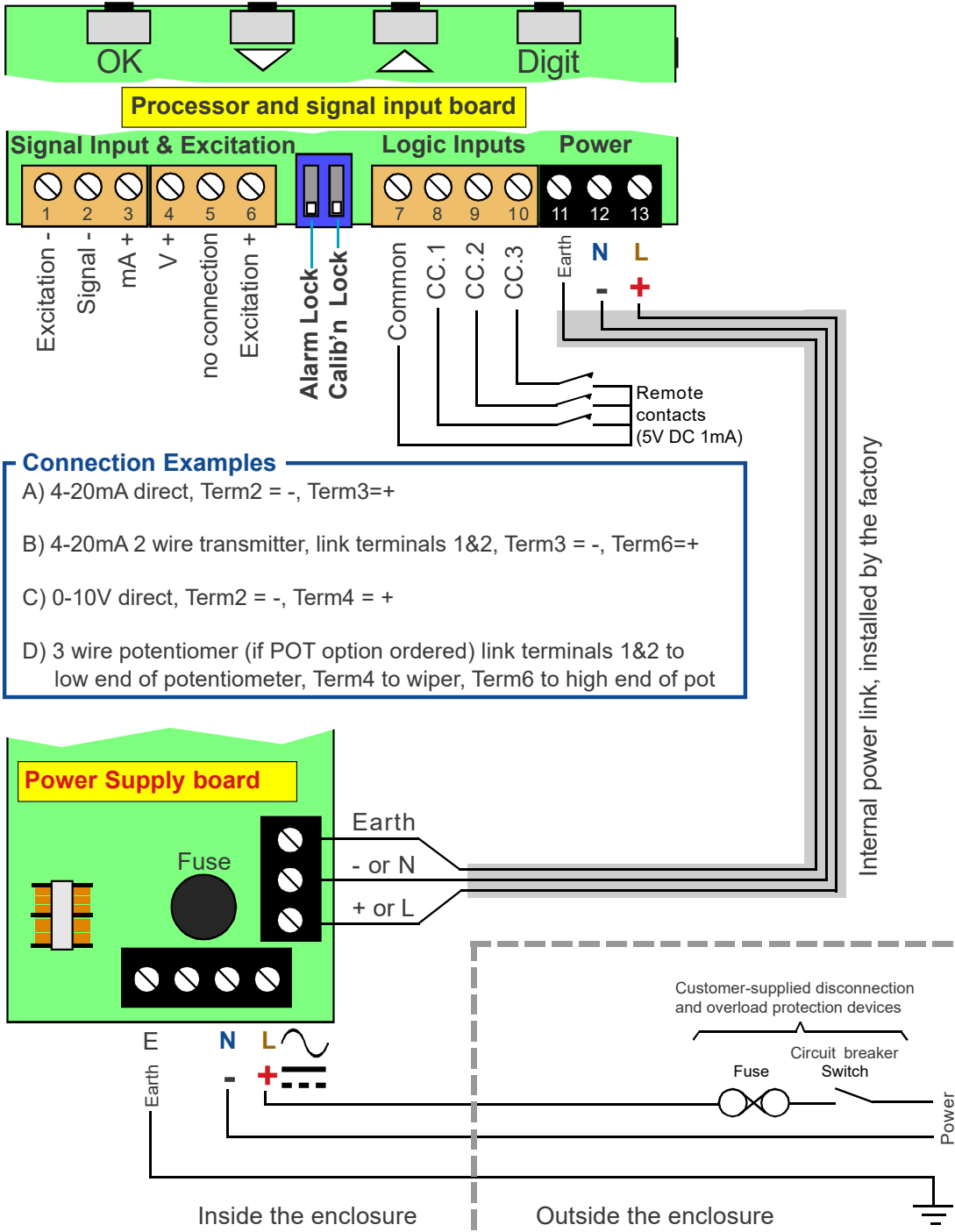

Connections

Warning:
Disconnect all power before removing the rear of the display

Connectors and options
Connectors may be present even if output options are not installed. Refer to rating label to see installed options.

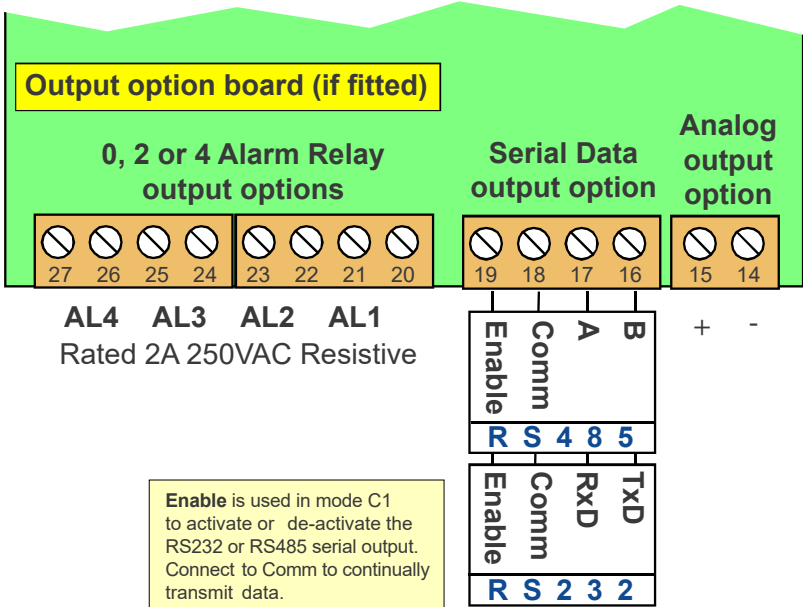

Remote programming button connector

On one of the display boards, you will find a 7 way connector, to which you can wire remote programming buttons, to allow adjustment of the display's settings when the display is inaccessible.

You can also enable or disable the display's front panel buttons, either by a remote contact closure, or by an on-board push-on jumper switch, which is located near to the remote button connector. When the contact is closed, or the push-on switch fitted, the front buttons are enabled.

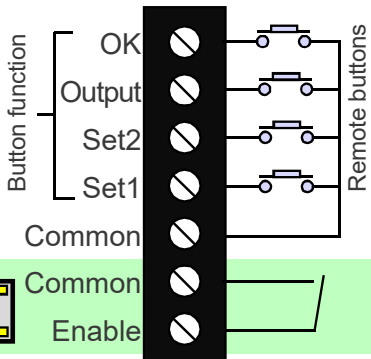

Close contact or fit jumper to enable front panel buttons

Display's front panel buttons enabled/disabled by jumper or connection

Rear case screws - please note

The rear panel is held in place with socket flange button head screws, which only need to be gently tightened, with the supplied 2mm hex key.

Do not use tools to tighten or loosen the screws, as this could cause damage to the internal threads.

Installation Hints For Best Performance

This section offers several suggestions which will help you get the best performance from your weighing system.

Load cells create very small signals which can easily be corrupted by electrical noise. These steps will ensure you get the best possible performance from your meter.

1. Use good quality screened signal cable, with twisted pairs. Belden 8777NH, Belden 9503 and AlphaWire 6010C are good choices, available from many electrical distributors.
2. If you are using multi-pair twisted cable, each pair should be dedicated to a single display as shown opposite, for maximum noise immunity. This will ensure that any electrical noise induced in the cable is properly cancelled. Mixing destinations carelessly amongst the twisted pairs can worsen noise performance.
3. The cable should be routed away from noisy wiring and devices such as power feeds from inverters, discharge-lighting cables, welder cabling etc, and should preferably be routed in a dedicated low-voltage signaling/instrumentation conduit or cable tray.
4. Screened cable should be earthed at the display end only.
5. All wires and screens coming out of the screened cable should be kept as short as possible to minimise pickup of noise.
6. If you are using barriers, you should earth your screen as shown below, paying particular care that you do not earth both ends of any run of cable.

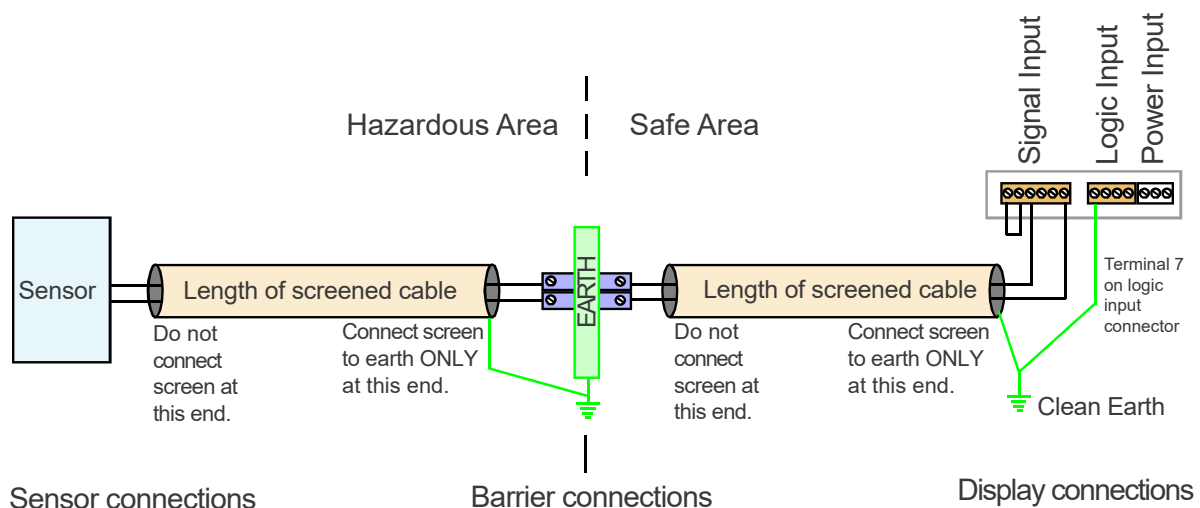

When using multi-core screened cable to connect several sensors to several displays, please be sure to use one twisted pair for each display and sensor.

Do NOT use a wire from one pair for signal positive and a wire from another pair for signal negative, as this will prevent the twisted cables from cancelling any induced electrical noise.

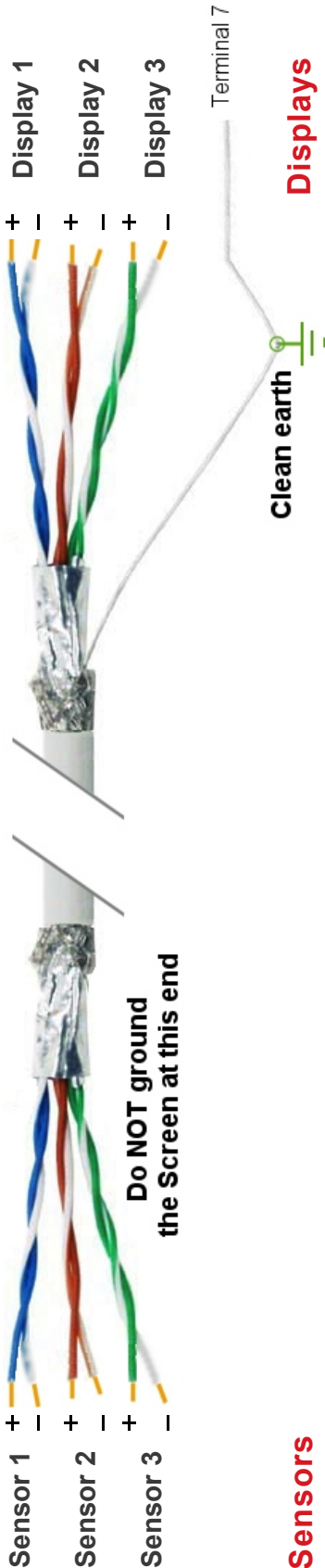

48V AC Power Wiring Option

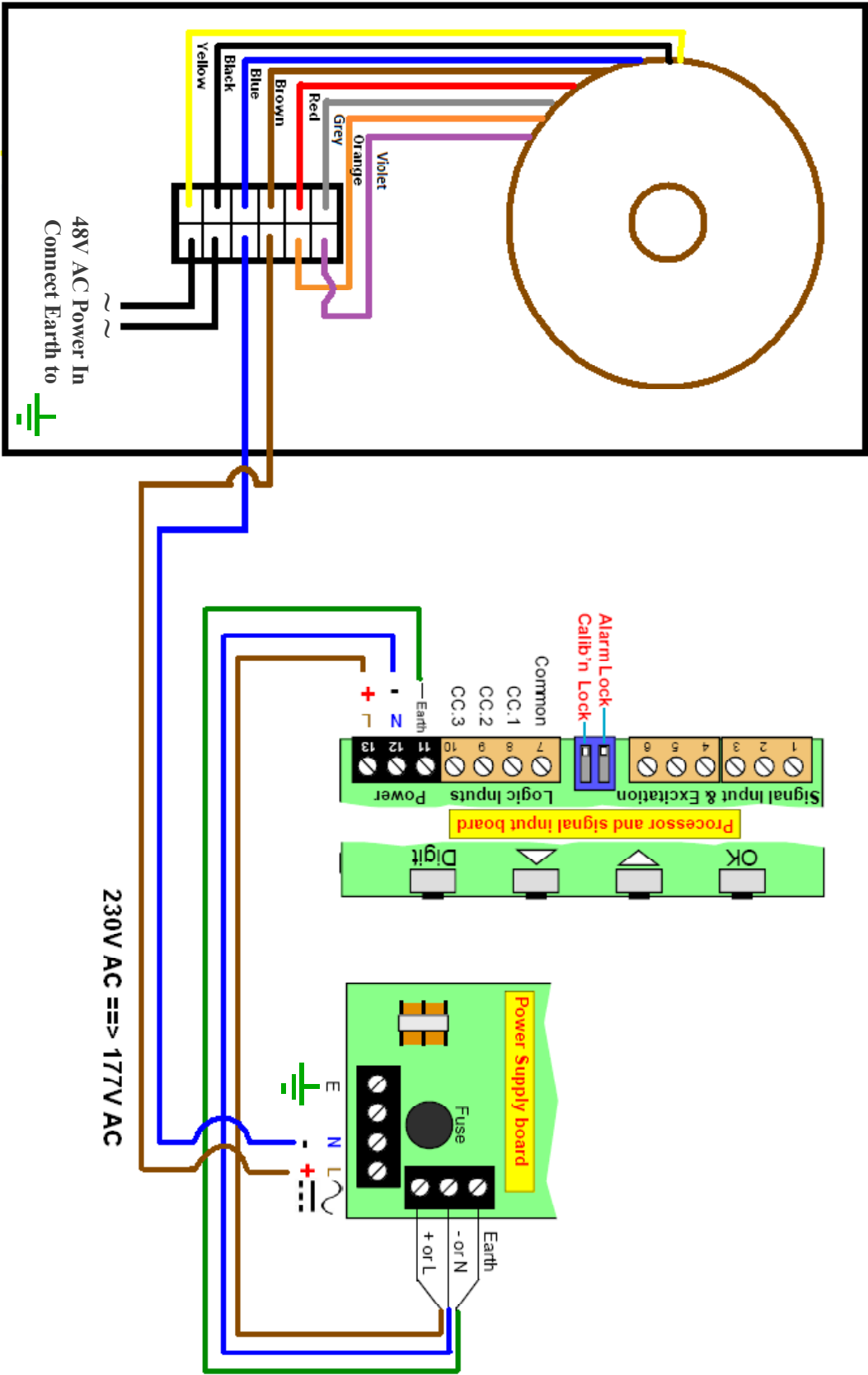

Display Brightness

You can adjust the display brightness at any time, provided the display is locked.

1

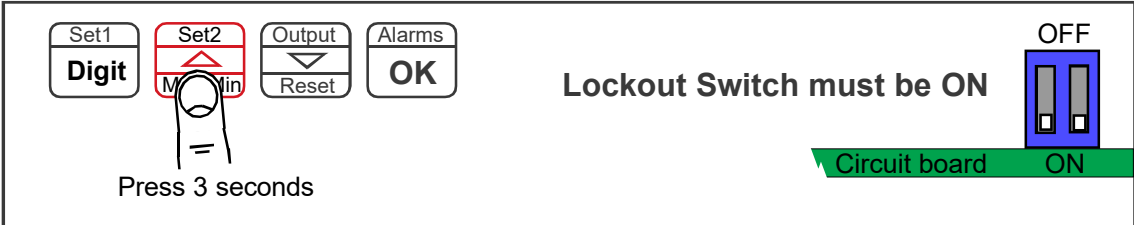

Set1 Digit Set2 Max/Min Output Reset Alarms OK

Press 3 seconds

Lockout Switch must be ON

Circuit board ON

2

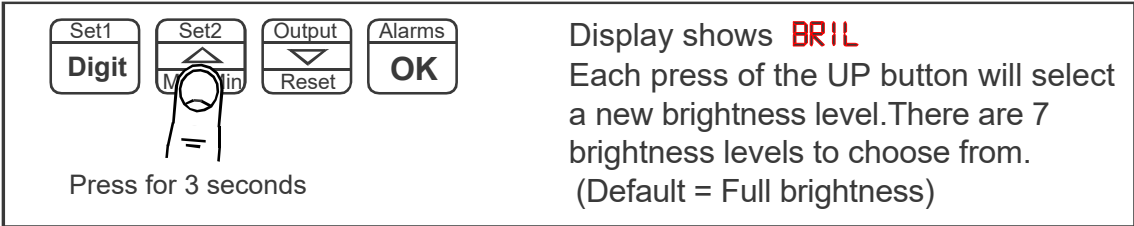

Set1 Digit Set2 Max/Min Output Reset Alarms OK

Press for 3 seconds

Display shows **BRIL**
Each press of the UP button will select a new brightness level. There are 7 brightness levels to choose from. (Default = Full brightness)

3



Set1 Digit Set2 Max/Min Output Reset Alarms OK

Press to accept

Done!



Did you know, we make this display in two brightness versions? Standard brightness for use inside, and Daylight Viewing for use outside in direct sunlight. The Daylight Viewing version has suffix -DLV in its part number.

Meter Calibration Modes

You can choose from two main calibration methods.

1. Direct Calibration - this is when you connect the meter to your system and make the meter read what you want it to, at 2 different points. *This is the preferred calibration method, because it allows you to calibrate the system as a whole.*

2. Theoretical Calibration - this is when you type in the sensor's theoretical signal level at the bottom and top of its range and then type in the value the display should show, for each signal level.

How to choose a calibration method:-

1



Press 3 seconds

Lockout Switch must be OFF

Circuit board ON

2

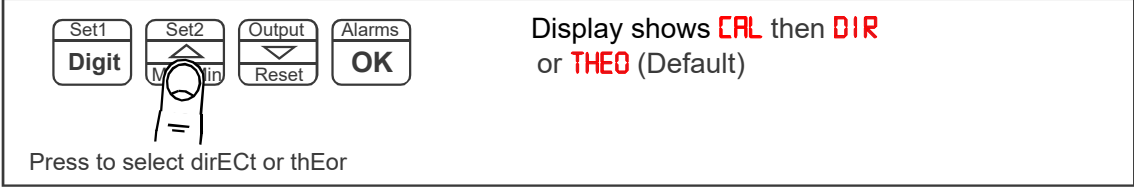

Press to select dirECT or thEor

Display shows **CAL** then **DIR** or **THEO** (Default)

3



Press to accept

If you chose Theoretical, you will now be asked whether your input signal will be DC Current or DC voltage ... the display will show **IMP** followed by **DC A** or **DC V**

4

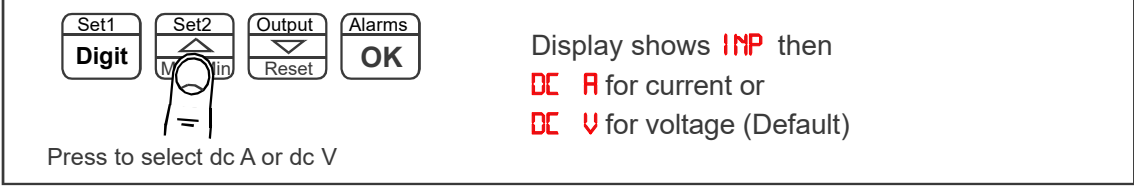

Press to select dc A or dc V

Display shows **IMP** then **DC A** for current or **DC V** for voltage (Default)

5



Press to accept

Done!





Direct Calibration - Full Scale Setting

This is when you connect the meter to your system and make the meter read what you want it to, at 2 different points. *This is the preferred calibration method, because it allows you to calibrate the system as a whole.*

How to do direct calibration:-

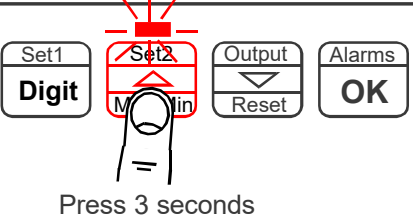
If you have not done so before, please select Direct Calibration mode from the previous page.

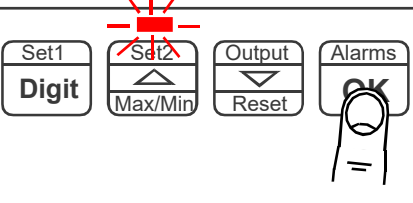
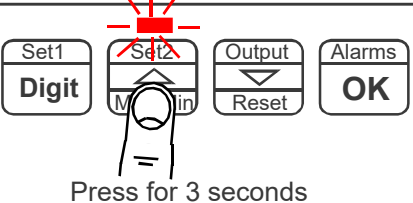
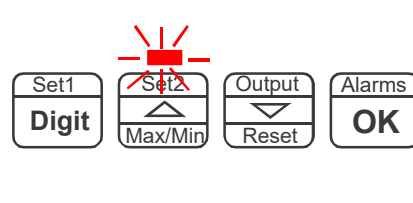
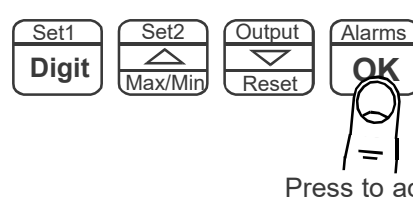
First we recommend you set the **FULL SCALE** calibration ...

1	 <p>Press 3 seconds</p>	<p>Lockout Switch must be OFF Display shows DIR followed by SET.H</p>  <p>Circuit board ON</p>
2		<p>Apply the highest calibration signal you can achieve, ideally 100% of system capacity. You can use less, but you will get better accuracy with higher signals. Now press OK</p>
3	 <p>Press for 3 seconds</p>	<p>Press Set2 for 3 seconds. You can now set your decimal point position using the UP or DOWN buttons. Press OK when done.</p>
4		<p>You can now set the display value you want to see - use DIGIT to select each digit in turn, and the UP or DOWN arrow to increase or decrease each digit's value, as required.</p>
5	 <p>Press to accept</p>	 <p>Done!</p>

Direct Calibration - Zero Setting

How to calibrate the **ZERO** point.

1

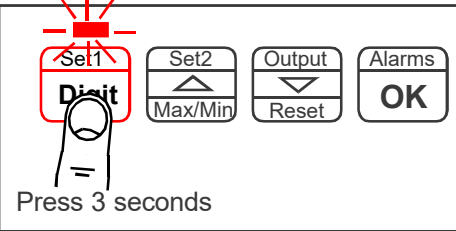

Press 3 seconds

Lockout Switch must be OFF

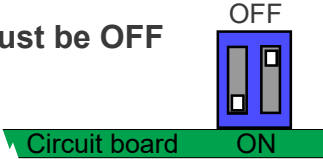

2

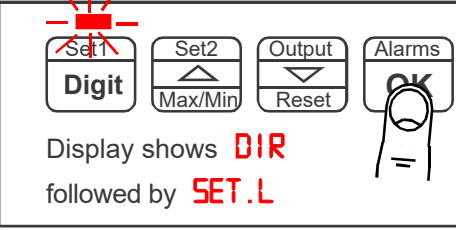

Display shows **DIR** followed by **SET.L**

Apply the lowest calibration signal you can achieve, ideally 0% of system capacity. Now press OK

3

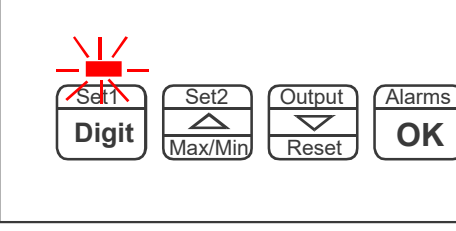

You can now set the display value you want to see - use DIGIT to select each digit in turn, and the UP or DOWN arrow to increase or decrease each digit's value, as required.

4

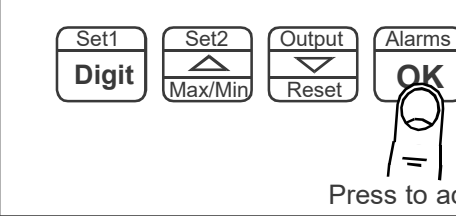

Press to accept



Done!

You can set Zero first, if you prefer, but you will not be able to change the decimal point position in the ZERO calibration step.

This will not be an issue if your zero calibration reading is 0, but may become confusing otherwise.

When you have finished your calibration, please remember to put the calibration lockout switch in its ON position, to protect your settings.

Linearisation with Direct Calibration

If your system is non linear, you can calibrate the meter and correct for this with the lineariser function.

You will need to apply a series of known loads, starting at 0 and working up to full scale. You will then tell the meter what it should read for each applied load. You can use up to 10 points.

First, you must select Direct Calibration Mode (see page on calibration Modes) Then, proceed as shown below...

- 1**

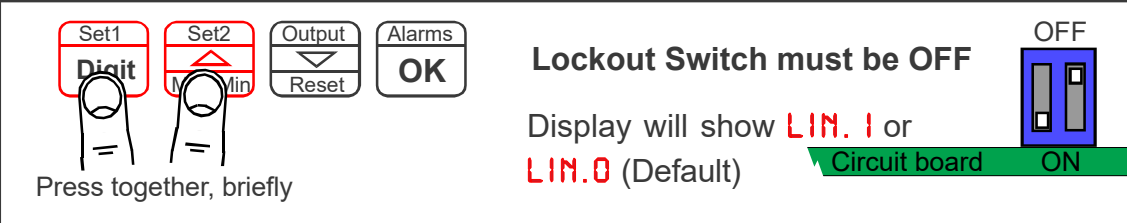

Press together, briefly

Lockout Switch must be OFF

Display will show **LIN. 1** or **LIN. 0** (Default)

Circuit board **ON**
- 2**

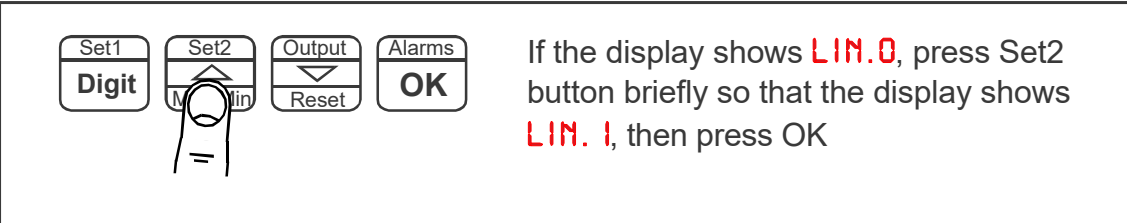

If the display shows **LIN. 0**, press Set2 button briefly so that the display shows **LIN. 1**, then press OK
- 3**

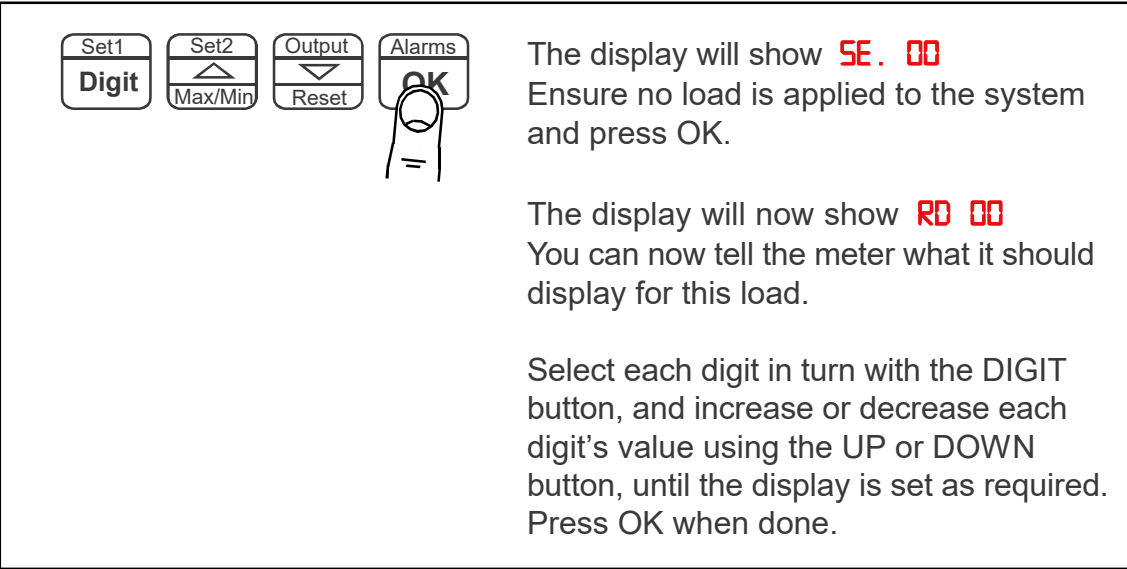

The display will show **SE. 00**

Ensure no load is applied to the system and press OK.

The display will now show **RD 00**

You can now tell the meter what it should display for this load.

Select each digit in turn with the DIGIT button, and increase or decrease each digit's value using the UP or DOWN button, until the display is set as required. Press OK when done.
- 4**

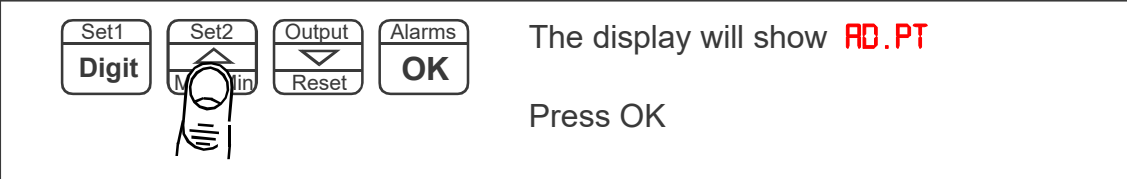

The display will show **RD.PT**

Press OK

Continued ...

Linearisation with Direct Calibration - Continued

5

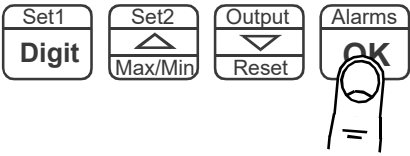

The display will show **SE. 01** Apply your 1st known load to the system and press OK.

The display will now show **RD 01** You can now tell the meter what it should display for this load.

Select each digit in turn with the DIGIT button, and increase or decrease each digit's value using the UP or DOWN button, until the display is set as required. Press OK when done.



6

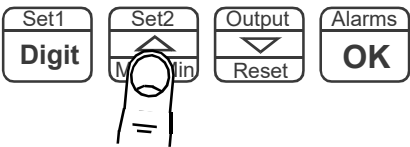

The display will show **RD.PT**

Press OK if you want to Add another calibration point, you will repeat the previous steps, each time incrementing "Set XX" and "rd XX" up to Set 09 and rd 09 which are the last available points.

If you want to finish adding points, press Set2 until the display shows **SAVE**, and then confirm by pressing OK

If you want to abort the setup, press Set2 until the display shows **QUIT** and then press OK

7

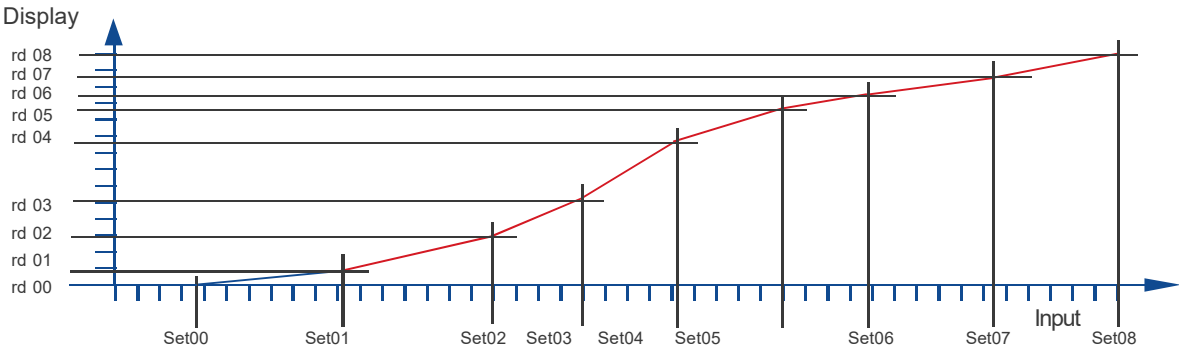
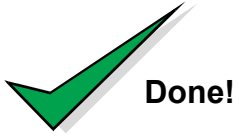
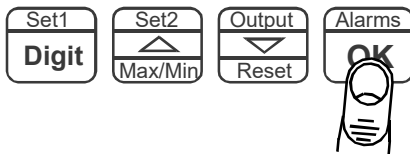

Theoretical Calibration - Decimal Point & Full Scale

This is when you type in the sensor's theoretical signal level at the top and bottom of its range and the value to display, for each signal level.



If you have not done so before, please select Theoretical Calibration mode from the **Meter Calibration** page AND choose whether your input is current or voltage.

First we recommend you set the **FULL SCALE** calibration ...

1

Press 3 seconds

Lockout Switch must be OFF

Circuit board ON

2

Display shows **THEO** followed by **DC A** or **DC V**, depending on whether you have chosen current or voltage input, then **IN HI**

3

Press to accept

You can now specify the maximum input signal. Use DIGIT to select each digit in turn, and the UP or DOWN arrow to increase or decrease each digit's value, as required. eg set **20.00** if your input is 4-20mA

4

Defaults are
4-20mA = 0-100.0 for dCA and
0-10V = 0-100.0 for dC V

Display now shows **RD HI** briefly. You can now specify the maximum reading and decimal point position. Press Set2 button for 3 seconds to set decimal point position. Use up and down arrows to move the decimal point and press OK when done. Then, use DIGIT to select each digit in turn, and the UP or DOWN arrow to increase or decrease each digit's value, as required. eg set 100.0 if your display range is 0 to 100.0

5

Press to accept

Done!

Theoretical Calibration - Low End Calibration

This is when you type in the sensor's theoretical signal level at the top and bottom of its range and the value to display, for each signal level.

If you have not done so before, please select Theoretical Calibration mode from the **Meter Calibration** page.

1

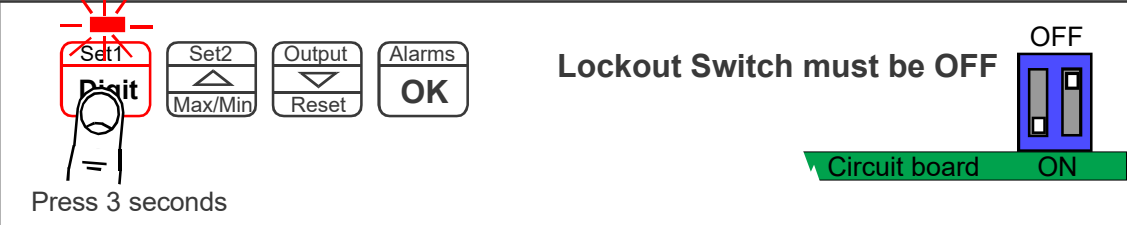

Press 3 seconds

Lockout Switch must be OFF

Circuit board ON

2

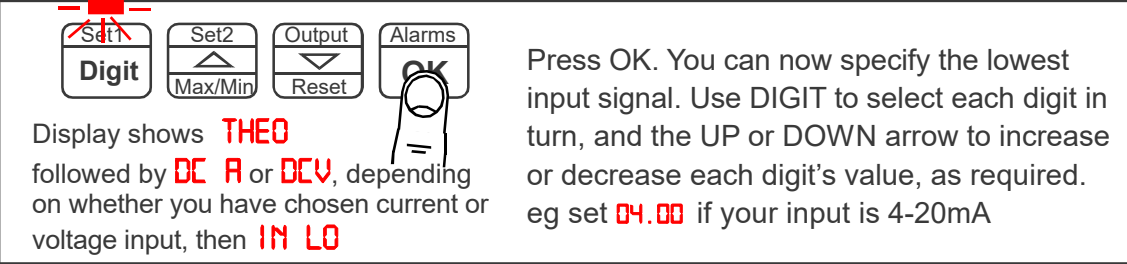

Display shows **THEO** followed by **DE A** or **DEV**, depending on whether you have chosen current or voltage input, then **IN LO**

Press OK. You can now specify the lowest input signal. Use DIGIT to select each digit in turn, and the UP or DOWN arrow to increase or decrease each digit's value, as required. eg set **04.00** if your input is 4-20mA

3



Press to accept

4

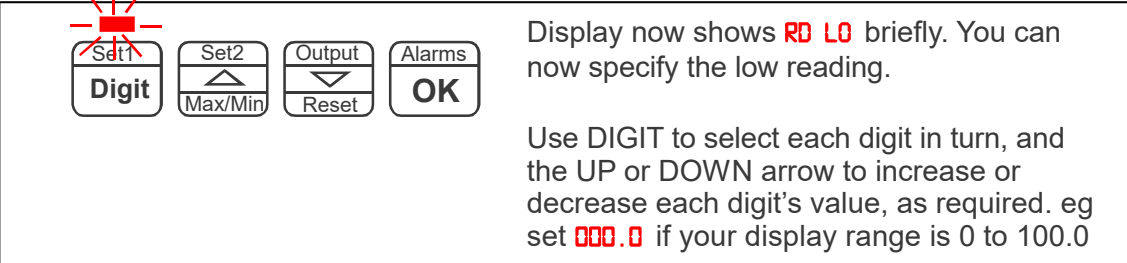

Display now shows **RD LO** briefly. You can now specify the low reading.

Use DIGIT to select each digit in turn, and the UP or DOWN arrow to increase or decrease each digit's value, as required. eg set **000.0** if your display range is 0 to 100.0

5

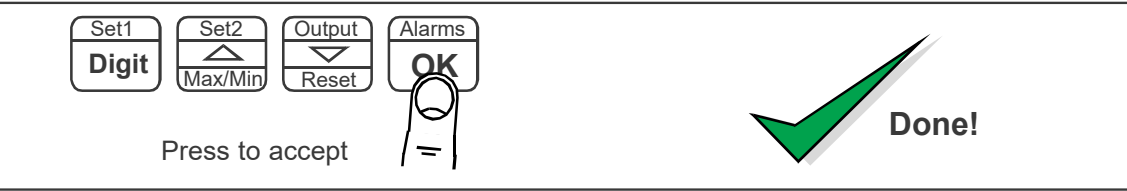

Press to accept

Done!

You can set Zero first, if you prefer, but you will not be able to change the decimal point position in the ZERO calibration step. This will not be an issue if your zero calibration reading is 0, but may become confusing otherwise.

Linearisation with Theoretical Calibration

If your system is non-linear, you can calibrate the meter and correct for this with the lineariser function.

With this method, you can enter theoretical values for input signal and display values, without having to connect a sensor.

First, you must select Theoretical Calibration Mode (see page on calibration Modes) Then, proceed as shown below...

- 1**

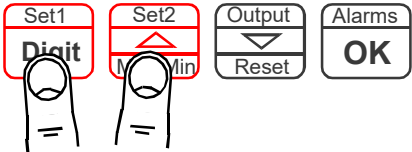

Press together, briefly

Lockout Switch must be OFF

Display will show **LIN. 1** or **LIN. 0**

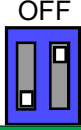

Circuit board ON
- 2**

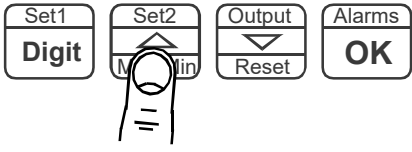

If the display shows **LIN. 0**, press Set2 button briefly so that the display shows **LIN. 1**, then press OK
- 3**

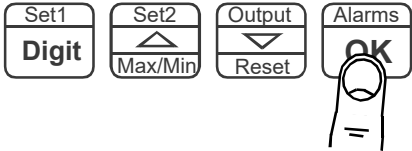

The display will show **IN 00** followed by an editing screen. Here you can enter your first calibration input signal level using DIGIT button to select each digit in turn. Increase or decrease the value of each digit using the UP or DOWN buttons. Press OK when set.

The display will now show **RD 00** You can now tell the meter what it should display for this input signal.

Select each digit in turn with the DIGIT button, and increase or decrease each digit's value using the UP or DOWN button, until the display is set as required. Press OK when done.
- 4**

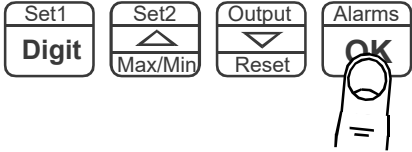

Display will show **RD.PT**

Press OK

Continued ...

Linearisation with Theoretical Calibration - Cont'd.

5

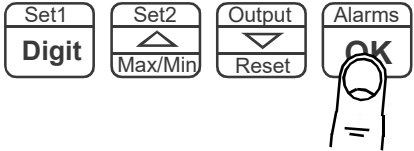

The display will show **IN 01** followed by an editing screen. Here you can enter your next calibration input signal level using DIGIT button to select each digit in turn. Increase or decrease the value of each digit using the UP or DOWN buttons. Press OK when set.

The display will now show **RD 01** You can now tell the meter what it should display for this input signal.

Select each digit in turn with the DIGIT button, and increase or decrease each digit's value using the UP or DOWN button, until the display is set as required. Press OK when done.



6

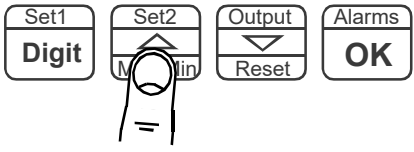

The display will show **RD.PT**

Press OK if you want to Add another calibration point, you will repeat the previous steps, each time incrementing **In XX** and **rd XX** up to In 09 and rd 09 which are the last available points.

If you want to finish adding points, press Set2 until the display shows **SAVE**, and then confirm by pressing OK

If you want to abort the setup, press Set2 until the display shows **QUIT** and then press OK

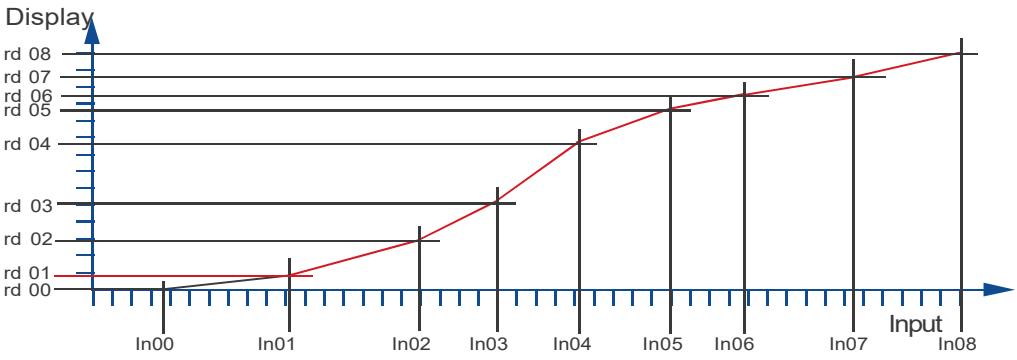
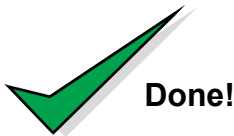

Sensor Drift Correction

If your system is normally reading 0, for example as is typical with platform scales or a torque meter, you may find a small amount of sensor drift caused by changes in temperature, ageing etc.

We can automatically correct for slow, long term drift, by comparing your signal to 0 every 30 seconds, and re-calibrating to remove any detected movement.

This does not affect the sensitivity of your system, and is only applied for readings less than 8 least-significant counts.

The corrected value is stored in non-volatile memory, so that any drift trend will be re-applied after you have switched off the meter.

1

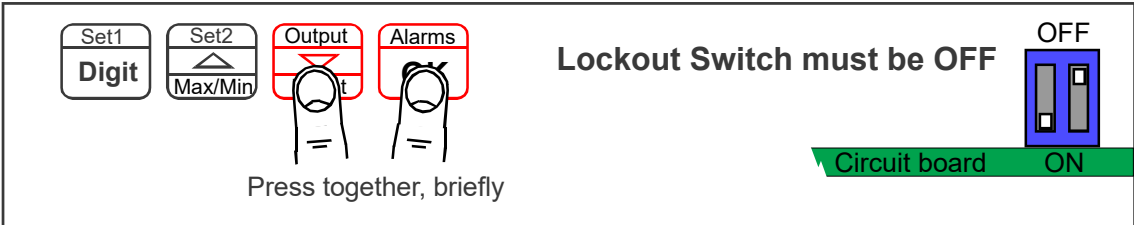

Set1 Digit Set2 Max/Min Output Alarms

Press together, briefly

Lockout Switch must be OFF

Circuit board ON

2

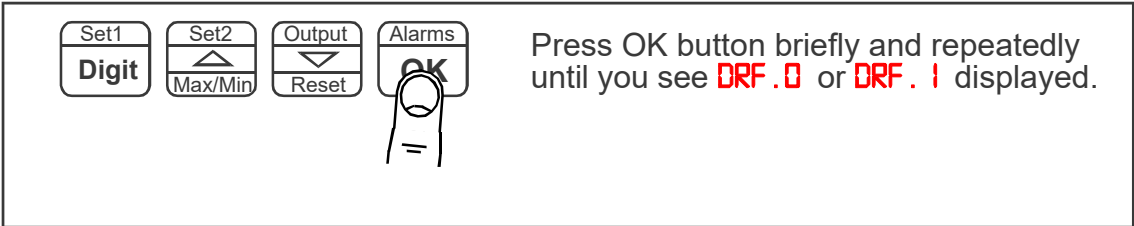

Set1 Digit Set2 Max/Min Output Reset Alarms OK

Press OK button briefly and repeatedly until you see **DRF . 0** or **DRF . 1** displayed.

3

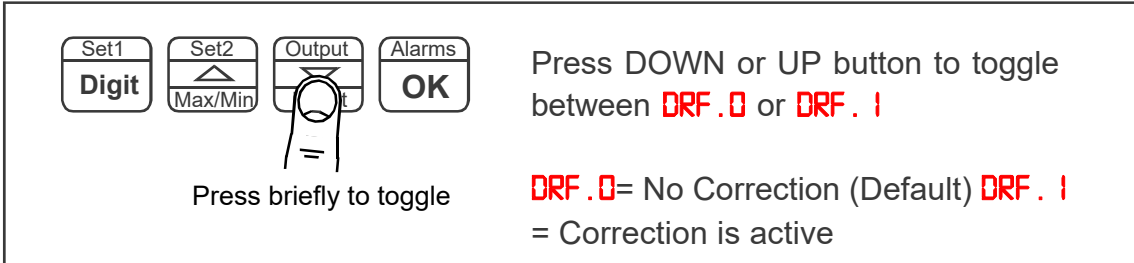

Set1 Digit Set2 Max/Min Output Alarms OK

Press DOWN or UP button to toggle between **DRF . 0** or **DRF . 1**

DRF . 0 = No Correction (Default) **DRF . 1** = Correction is active

4

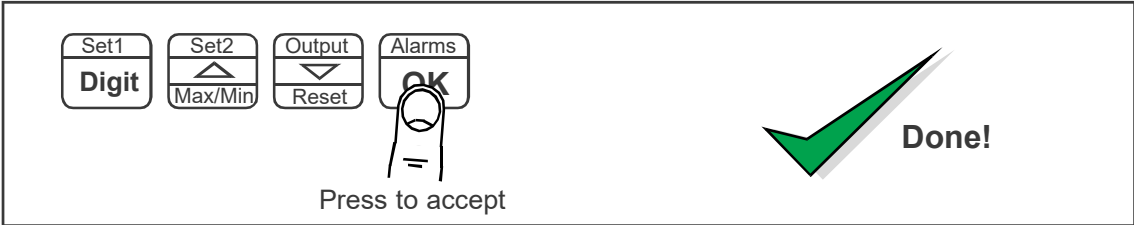

Set1 Digit Set2 Max/Min Output Reset Alarms OK

Press to accept

Done!

Logic Input Functions

The three contact closure inputs on the rear of the meter have default functions which are:-

- Contact closure 1 = Tare
- Contact closure 2 = Peak/Valley display
- Contact closure 3 = Reset

You can re-assign these to include :HOLD, Nett/Gross value display, Memory page address 1,2 or 4 (only if Multi-memory MEM option is installed)

1

Lockout Switch must be OFF

OFF

Circuit board ON

Press 3 seconds

2

Press repeatedly until you see **CC. 1**, followed by the existing function for Contact Closure 1.

After you have set **CC. 1**, you will get the prompt **CC. 2** to allow you to set Contact Closure 2 function and when you have set CC.2 you will get the prompt **CC. 3** to allow you to set Contact Closure 3 function

3

Use UP or DOWN buttons to select from these available functions...

Defaults are:-

CC. 1 = TARE	TARE = Tare display to 0
CC. 2 = PV	PV = Peak/Valley toggle
CC. 3 = RST	RST = Reset
	HOLD = Freeze display
	NT.GR = Nett / Gross display
	PA. 1 = Page Address 1*
	PA. 2 = Page Address 2*
	PA. 4 = Page Address 4*

4

Press to accept

Done!

* Only available if the Multi-memory MEM option is installed

Logic Input Connections & Front Buttons

The previous page explained how to select the functions of the 3 logic inputs. You can connect remote contact closures or open NPN collectors to activate these logic inputs.

The logic input provides a 5V DC signal. When you connect this to common, a current of 1mA will flow. Because this is a small signal, we recommend you use switches with gold plated contacts, or self cleaning contacts, for best long term reliability.

The logic inputs are not galvanically isolated from the input signal.

The logic inputs are only activated when the lockout switch is ON

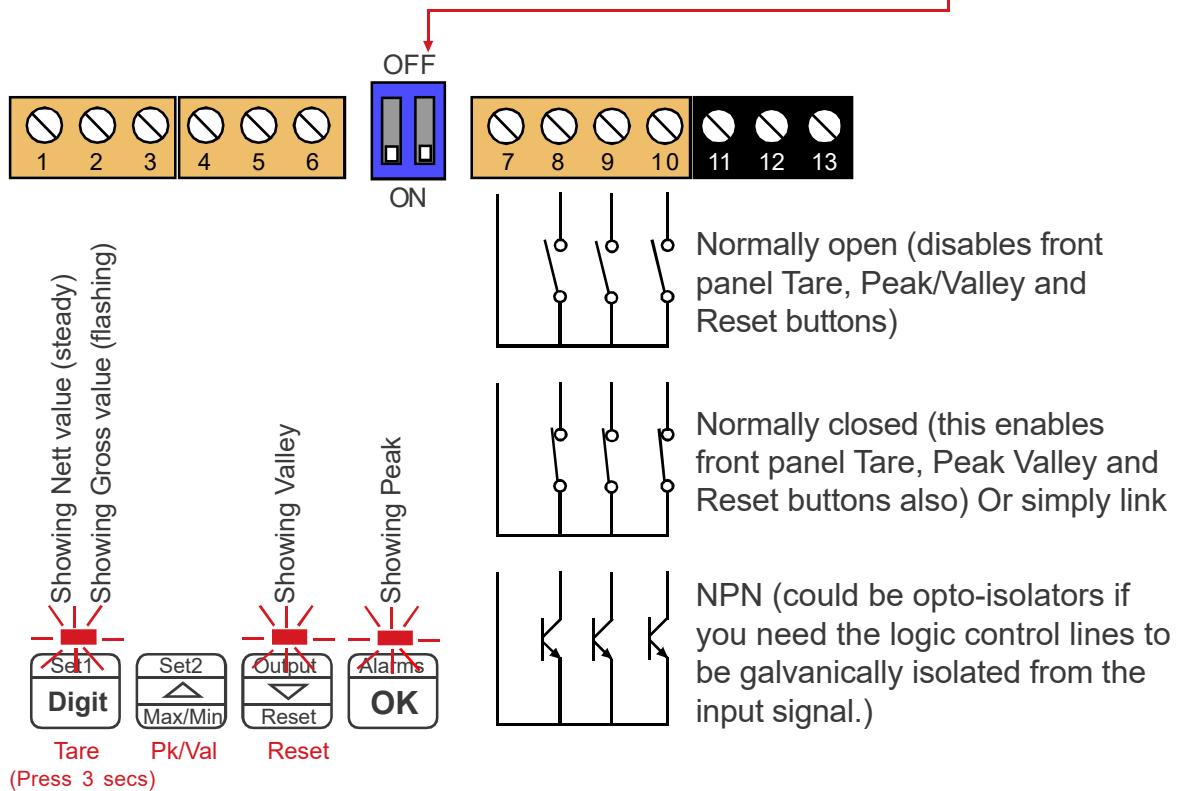

- TARE** = Tares display to 0. Often used in weighing systems to zero a display prior to making a measurement. Net weight is shown once tared. When a display has been tared the small LED above the Set1 button will be illuminated.
- PV** = Peak/Valley toggle. Allows you to view the maximum and minimum values which have been displayed since last reset. 0% LED illuminates when showing valley, 100% LED illuminates when showing peak.
- RST** = Reset. This clears any tare, peak, valley, alarm latch
- HOLD** = Freezes the displayed value for as long as the Hold input is closed
- NT.GR** = Allows you to toggle between Nett and Gross values on the display
- PA. 1 ..4** = Page Addresses, if MEM option is installed.

Factory Defaults

You can return the display to its factory default conditions whenever you wish. If you do so, you will permanently lose all your settings and will need to start from the beginning again.

The calibration Audit Counter will NOT be reset, there is no way provided to reset this value, as it is intended as a secure record to indicate whether changes have been made to the display since it was last calibrated..

1

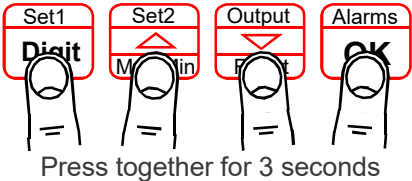

Press together for 3 seconds

Lockout Switch must be OFF

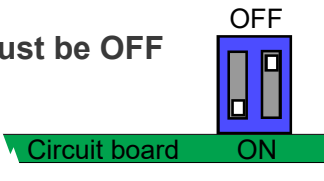

Circuit board ON

2

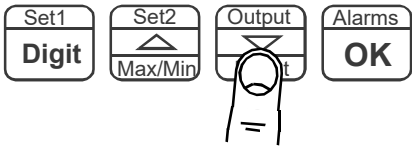

Display shows :- DEF.N (Defaults no)

Press the DOWN button to change the display to DEF.Y (Defaults Yes) if you want to return to default conditions.

3

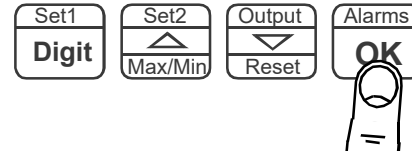

Press to accept



Done!

Calibration Audit Number

Your display includes a non-resettable counter which increments each time you make a change to the display's calibration. This is useful if you want to check whether a display has been altered since it was last calibrated.

The Calibration audit number starts at CL.01 up to CL.FF allowing up to 255 alterations to be recorded. Whenever you want to check the calibration audit number, press and hold the 2 outer buttons (Set1 + Alarms) for more than 3 seconds.

1

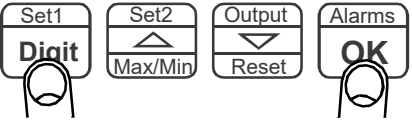

Press together for 3 seconds



Done!

Signal Filtering / Averaging

You can adjust the filtering time constant to reduce the effect of noise or instability on your input signal. A larger FIL value will give a more stable display, but the response to signal changes will be slower.

Because your output options, such as analogue output, alarm relays and serial output are all derived from the displayed value, they will respond at the same rate as the filtered display.

1

Press 3 seconds

Lockout Switch must be OFF

OFF

Circuit board ON

2

Select, then press OK to accept

Display shows **FIL.XX.X** where **XX.X** is the time constant in seconds. Use the UP or DOWN button to increase or decrease this value (Default = **FIL. 00.0**)

3

Press to accept

Done!

See also Filter Jump setting if your signal is particularly noisy and you cannot get sufficient smoothing with this filter.

This meter also includes an active filter for removing the effects of vibration. It is shipped with the filter enabled for maximum stability. You can move a push-on jumper switch to change the filter response to maximum speed if you wish. See below.

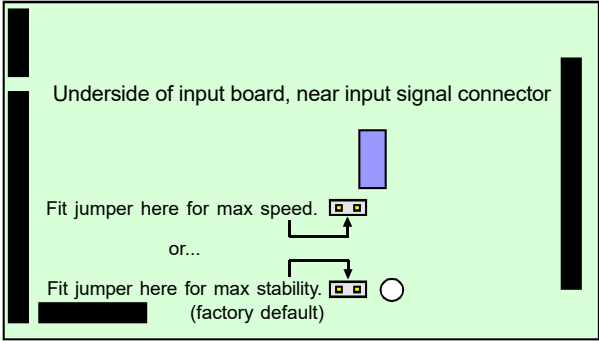

Filter Jump Value

The Filter Jump value allows you to decide how the display will respond to a process step change. It does this by overriding the filtering, if the input signal moves by more than a chosen amount in one conversion. The Filter Jump default value is 10%.

This means that for noise amplitude which has a peak value of less than 10% of the input range, filtering will be applied. Any signal movement greater than 10% of the input range will cause the display to jump immediately to that value, without filtering. After that jump, normal filtering will be re-applied, provided signal movement thereafter is less than 10% per conversion.

Guidance:

For noisy systems, increase the Filter Jump value up to a maximum of 99. Choose a value which gives a good compromise between filtering and response speed.

For reasonably clean signals, a Filter Jump value of around 10 or less will give a good compromise between filtering and response speed to step change inputs.

1

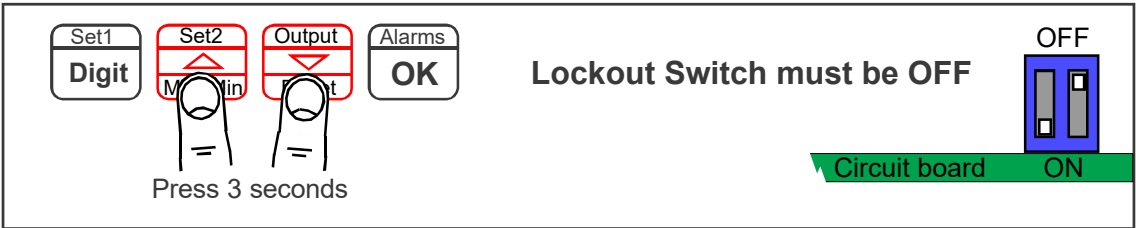

Set1 Digit Set2 Max/Min Output Reset Alarms OK

Press 3 seconds

Lockout Switch must be OFF

Circuit board ON

2

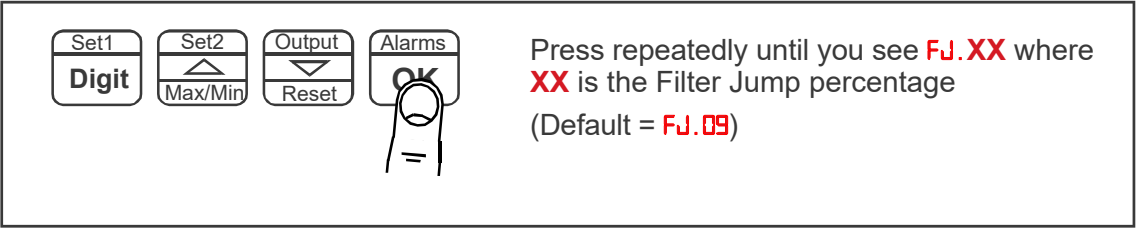

Set1 Digit Set2 Max/Min Output Reset Alarms OK

Press repeatedly until you see **FJ.XX** where **XX** is the Filter Jump percentage (Default = **FJ.09**)

3

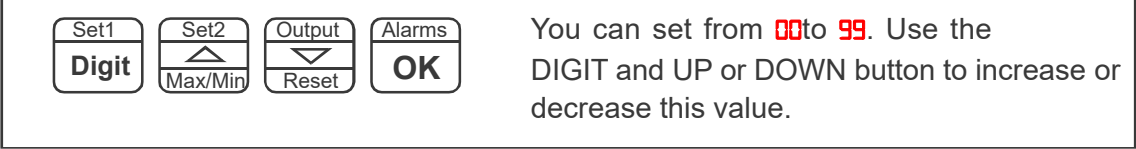

Set1 Digit Set2 Max/Min Output Reset Alarms OK

You can set from **00** to **99**. Use the DIGIT and UP or DOWN button to increase or decrease this value.

4

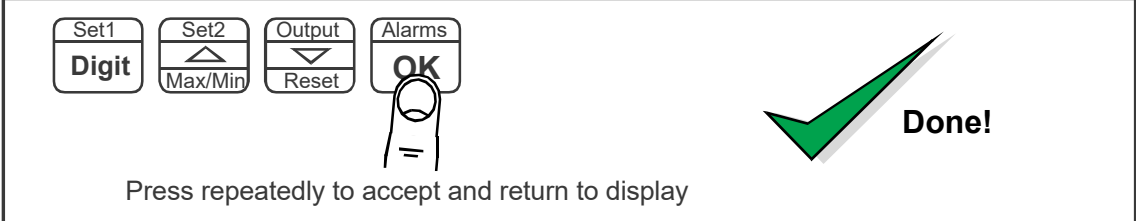

Set1 Digit Set2 Max/Min Output Reset Alarms OK

Press repeatedly to accept and return to display

Done!

Last Digit Rounding Up By 1, 2, 5, 10, 20 or 50

You can adjust the way the display rounds up, which is useful if you want to display a very large number, but do not want jitter on the last digit.

The display can be set to round up to the nearest 1 (no rounding) 2, 5, 10, 20 or 50

1

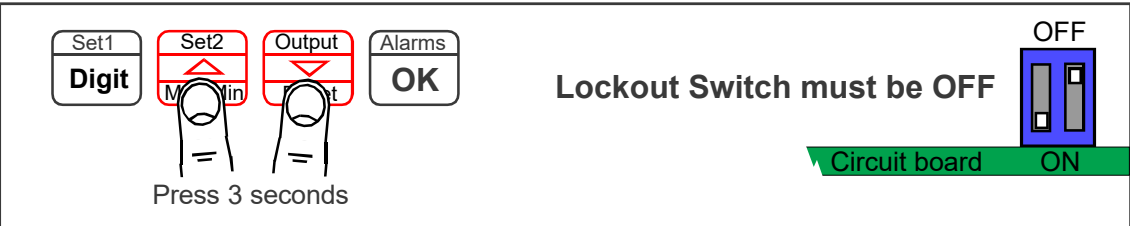

Set1 Digit Set2 Max/Min Output Reset Alarms OK

Press 3 seconds

Lockout Switch must be OFF

Circuit board ON

2

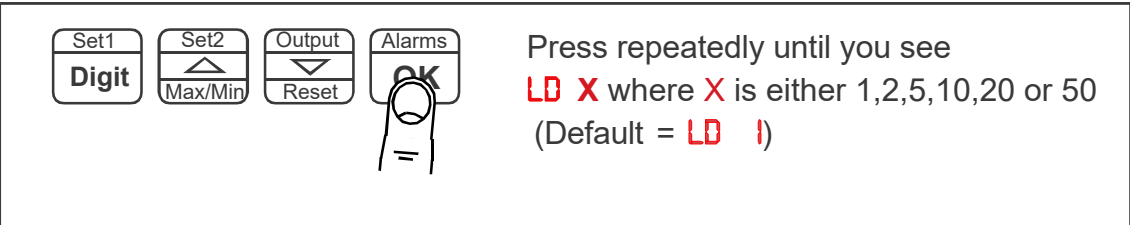

Set1 Digit Set2 Max/Min Output Reset Alarms OK

Press repeatedly until you see **LD X** where **X** is either 1,2,5,10,20 or 50 (Default = **LD 1**)

3

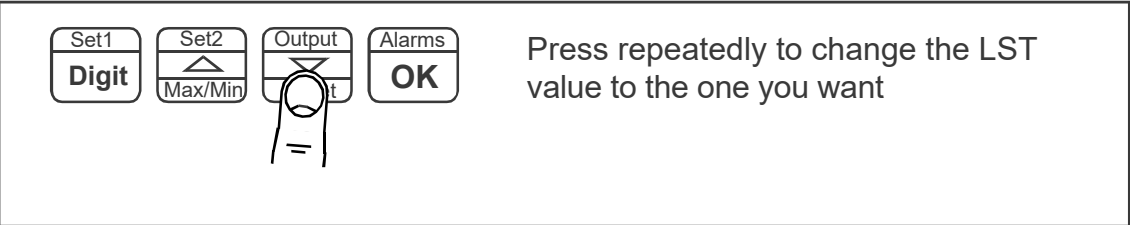

Set1 Digit Set2 Max/Min Output Reset Alarms OK

Press repeatedly to change the LST value to the one you want

4

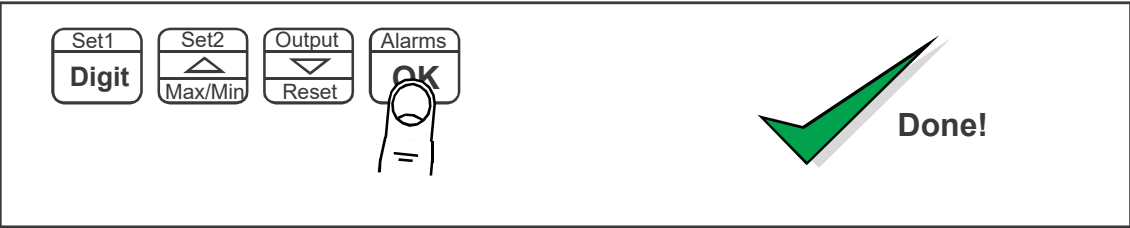

Set1 Digit Set2 Max/Min Output Reset Alarms OK

Done!

Scale Factor Adjustment

After you have calibrated your meter, you can use the SCALE feature to make fine adjustments to calibration, without affecting the calibration itself.

Example

Changing volume units of measure from litres to Imperial gallons

You could also use the SCALE to convert your readout from litres to imperial gallons, with- out affecting the calibration. Simply set SCALE = 0.220 and your meter which was calibrated in litres will now read in imperial gallons.

Changing weight units of measure from kg to pounds

You could also use the SCALE to convert your readout from kg to pounds, without affecting the calibration. Simply set SCALE = 2.205 and your meter which was calibrated in kg will now read in pounds.

1

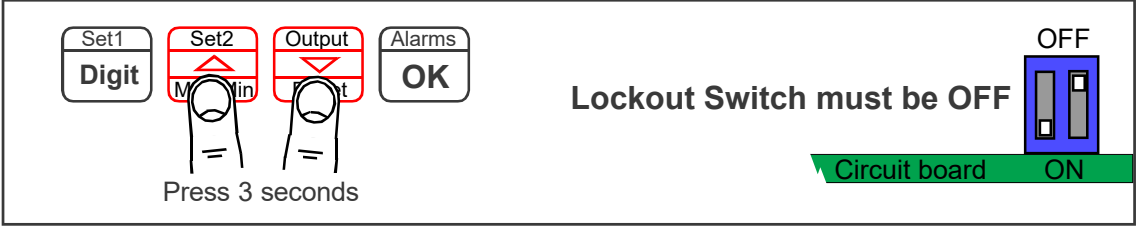

Press 3 seconds

Lockout Switch must be OFF

Circuit board ON

2

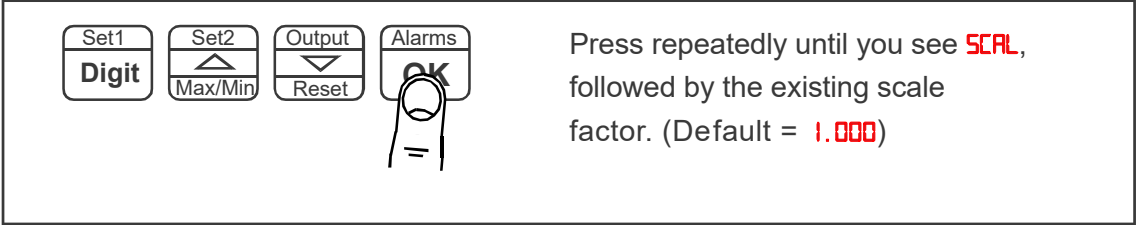

Press repeatedly until you see **SCAL**, followed by the existing scale factor. (Default = **1.000**)

3

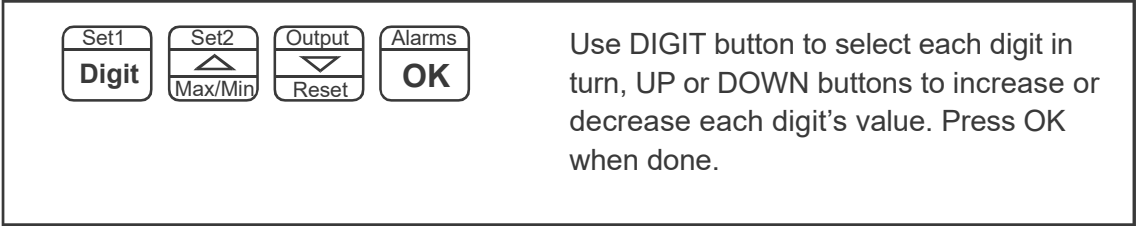

Use DIGIT button to select each digit in turn, UP or DOWN buttons to increase or decrease each digit's value. Press OK when done.

4

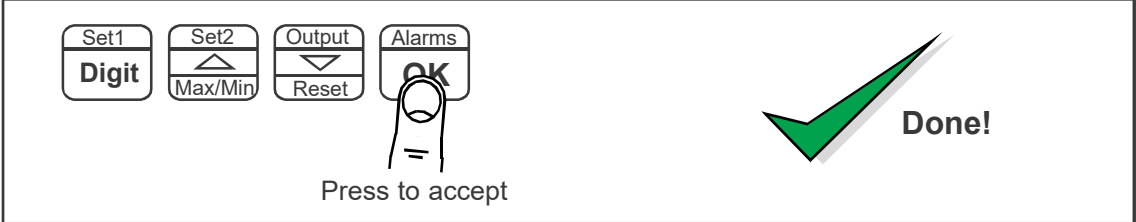

Press to accept

Done!

You may want to adjust an offset value also, see separate OFFSET page for this feature.

Offset Adjustment

After you have calibrated your meter, you can use the **OF.ST** feature to make fine additions or subtractions to the reading, without affecting the calibration itself.

1

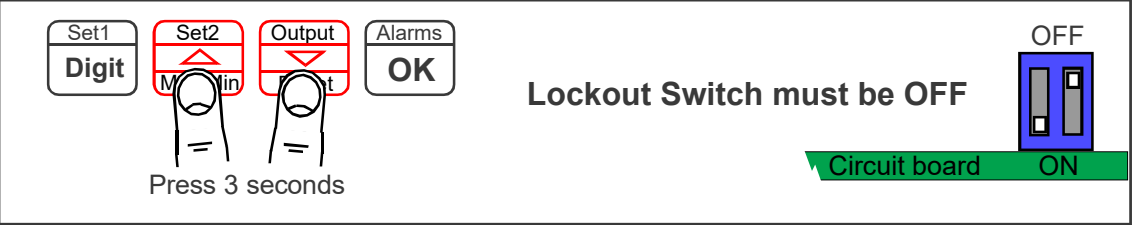

Set1 Digit Set2 Max/Min Output Alarms OK

Press 3 seconds

Lockout Switch must be OFF

Circuit board ON OFF

2



Set1 Digit Set2 Max/Min Output Alarms OK

Press repeatedly until you see **OF.ST**, followed by the existing offset value. (Default is **0.000**)

3

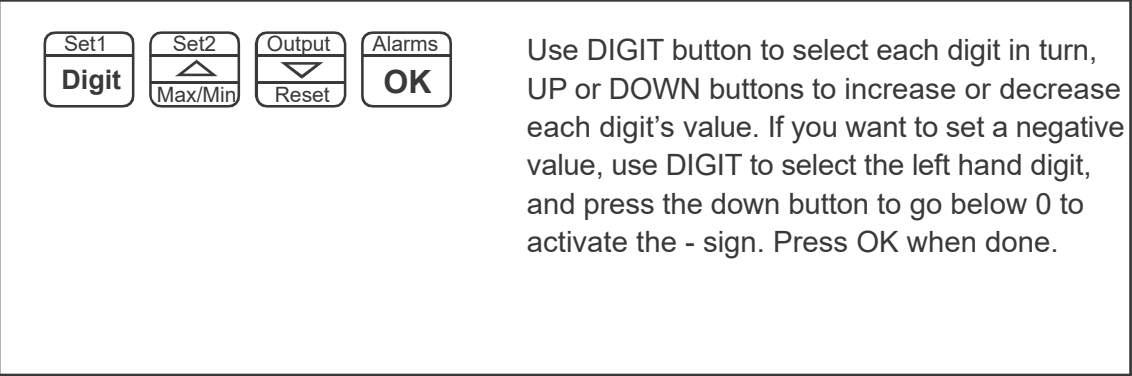

Set1 Digit Set2 Max/Min Output Alarms OK

Use DIGIT button to select each digit in turn, UP or DOWN buttons to increase or decrease each digit's value. If you want to set a negative value, use DIGIT to select the left hand digit, and press the down button to go below 0 to activate the - sign. Press OK when done.

4

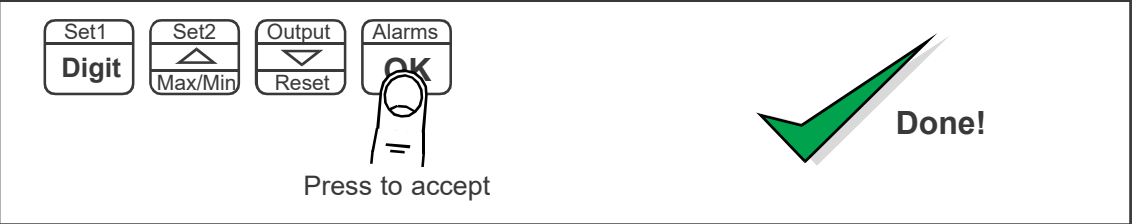

Set1 Digit Set2 Max/Min Output Alarms OK

Press to accept

Done!

You may want to adjust a SCALE FACTOR value also, without affecting calibration. See the separate SCALE page for this feature.

Menu Timeout Adjustment

The display has a default timeout of 60 seconds, to allow you sufficient time to refer to the manual between key operations.

You can make this period shorter, if you wish, once you become more familiar with the setup method.

1

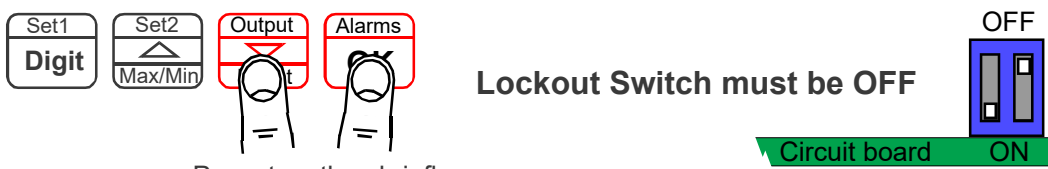

Press together, briefly

Lockout Switch must be OFF

Circuit board ON

2

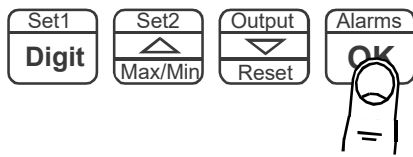

Press repeatedly until you see **09. XX** where **XX** is the delay in seconds. Choices are ...

09. 1	0
09. 20	20
09. 30	30
09. 60	(default)

3

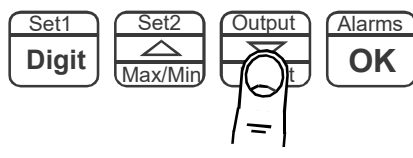

Press DOWN or UP button briefly and repeatedly to choose from

09. 10 or **09. 20** or **09. 30** or **09. 60**

Press briefly to toggle

4

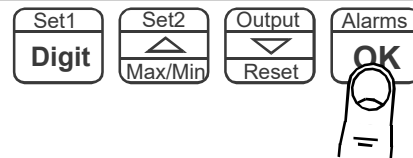

Press to accept

Done!

Reverse Display Function (Mirror Image)

If you need to be able to see a reflection of the display in a mirror or other reflective surface, for example in a simple heads-up system, or for drivers reversing into a bay, using mirrors only, you can set the display to show as a mirror image.

1

Press together, briefly

Lockout Switch must be OFF

Circuit board ON

2

Press OK button briefly and repeatedly until you see

REV. 0 (Default) or
REV. 1

3

Press DOWN or UP button briefly and repeatedly to choose from

REV. 0 (normal display) or
REV. 1 (mirror image display)

4

Press to accept

Done!

REV. 0



Example of normal display format displaying the number 876543

REV. 1



Example of Mirror Reverse display format displaying the number 876543

Bootup Routine & Tare Save Choices

When you switch on your meter, it can be set to power up with 3 possible summary message combinations. The choices are:-

- BT 0** = Segment test, followed by a full summary of software revision, calibration audit number, model number, installed options.
- BT 1** = Segment test followed by model number (Default)
- BT 2** = No summary, meter displays the measurement value immediately power is applied.
- BT 3** = All segments illuminate permanently, until a button is pressed.

1

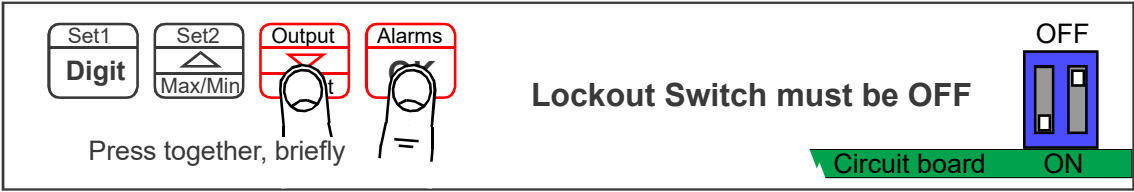

Press together, briefly

Lockout Switch must be OFF

2

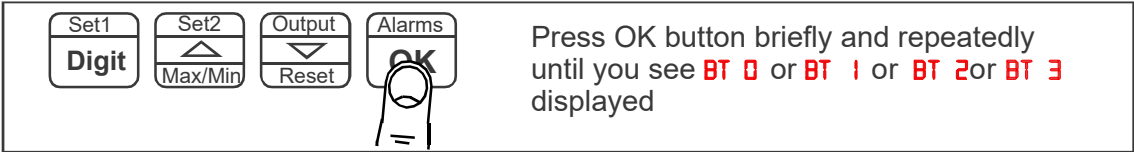

Press OK button briefly and repeatedly until you see **BT 0** or **BT 1** or **BT 2** or **BT 3** displayed

3

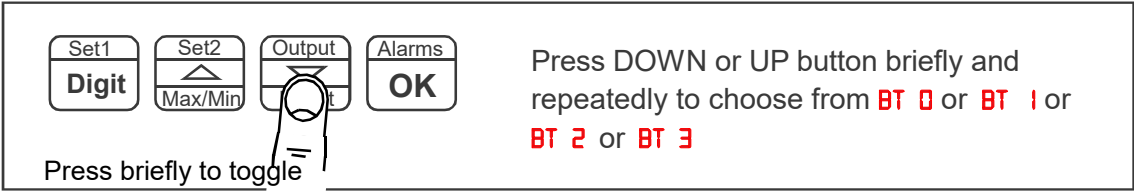

Press DOWN or UP button briefly and repeatedly to choose from **BT 0** or **BT 1** or **BT 2** or **BT 3**

Press briefly to toggle

4



Press to accept

5

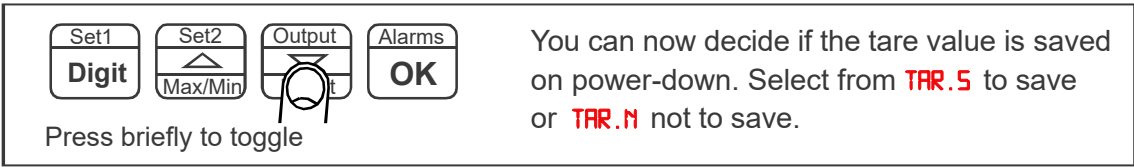

Press briefly to toggle

You can now decide if the tare value is saved on power-down. Select from **TAR.5** to save or **TAR.N** not to save.

6



Press to accept

Done!



You can trigger the full summary message whenever you want, without having to power the meter off, by pressing and holding the 2 outer buttons (Set1 + Alarms) for more than 3 seconds.

Multi-Program Memory Option ‘MEM’

The three contact closure inputs on the rear of the meter may be used to call up between 1 to 7 additional meter setup memories (pages), if the MEM option has been installed. This allows you to save up to 8 complete sets of independent calibrations, alarm settings, analogue output settings and serial comms settings.

First decide how many memory pages you want, as this will determine how many logic inputs you will need to use for the addressing. Logic inputs not required for Page Addressing can be used for other functions such as Tare, Reset, Display Hold, Peak/Valley display.

If you have used all 3 logic inputs for Page Addressing, you can still use the meter’s front panel buttons to perform Tare, Reset and peak/Valley view.

See “Contact Closure Input Functions” page for CC.1, CC.2, CC.3 & COP settings

Total number of pages	Logic Inputs required for addressing
1	none, standard single page meter
2	1 Set CC.1 = PA.1
3 or 4	2 Set CC.1 = PA.1, Set CC.2 = PA.2
5 to 8	3 Set CC.1 = PA.1, Set CC.2 = PA.2, Set CC.3 = PA.4

1. Set lockout switches OFF, and set page address to 0 or unplug the logic connector.
2. Set the copy instruction to **COP. 1** in page address 0 (found after you set CC3) .
3. Press all 4 buttons together, display shows **DEF . N**
4. Press the Up arrow to change display to **DEF . Y** and press OK.
5. If you want all channels to share a common setting, eg. calibration, do that setting now.
6. When you want to do separate settings for each channel, set COP.0

Programming and recalling individual pages

Plug the logic input connector back in, if you removed it earlier. Select a page address using the switch combinations shown below, wired to the Logic Input connector ...

Page address 0	All logic inputs open
Page address 1	CC.1 closed to Common
Page address 2	CC.2 closed to Common
Page address 3	CC.1 and CC.2 closed to Common
Page address 4	CC.3 closed to Common
Page address 5	CC.1 and CC.3 closed to Common
Page address 6	CC.2 and CC.3 closed to Common
Page address 7	All logic inputs closed to Common

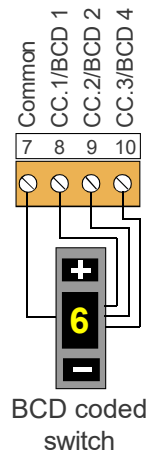

Perform the settings you require, according to the pages in this manual. Do this for all page addresses required. Then put the lockout switch in its ON position. Now, if you select a page address, the meter will briefly confirm the chosen page address on screen, and will then function according to the settings you programmed for that address.

Suitable BCD coded switches are available from many electrical supply stores. For example consider Kraus & Naimer part A540-600 E24 or Apem part number IRBC10N1248 or London Electronics part number SW2P-8W-BCD, which also provides separate 2 pole 8 way signal selection function.

Error Codes & Fault Findings



1. Under Range. The meter is being asked to display a value which is more negative than its limit of -1999



2. Over Range. The meter is being asked to display a value which is higher than its limit of 9999

These fault codes could be displayed because the signal is too negative, too positive, or because there is a wiring error, or because the display's scaling has been adjusted to give excessive sensitivity, or because there is a fault in the display.

a. If you are connecting a 4-20mA signal to the display, please measure the DC millivolt signal between terminals 2(-) and 3(+). Ideally, you will measure 132mV at 4mA and 660mV at 20mA.

If the voltage is much higher, there may be a problem with the 33 Ohm input shunt resistor.

You can verify this as follows...

Remove the input signal and power connectors to the meter, and measure the resistance between terminals 2 and 3. This should be 33 Ohms. If it is more than this, the resistor has probably been overloaded and burned by having a voltage connected across it. Please check your field wiring to ensure that no more than 30mA or 1V can be applied to the current input terminals.

Sometimes excessive current can feed to the current input of the display if your 2 wire 4-20mA transmitter is faulty or is wired incorrectly, because we rely on the transmitter to regulate the loop current between 4 and 20mA. The excitation power supply for the loop may have a much higher capacity than 20mA.

b. If the measurements above were satisfactory, the problem may be caused by the scaling being too sensitive.

If you are happy to do so, it is a simple matter to reset the display's scaling to the factory default conditions. Put the lockout switch off and press all 4 buttons together for around 3 seconds until the display shows "dEFS n". Then press the UP button once so the display shows "dEFS Y". Now press the OK button and the display will be reset to factory defaults.

If still no success, please return the display to us for the attention of our QA Manager, with a report of what you found, for repair.

How To Install Option Boards



Where the product is intended for "UL" installations removal or addition of option boards is not permitted.



Warning: Disconnect power before you expose the internals of the display

If you want to open your display to install or modify option boards, follow these steps...

- 1) Switch off power to the display and unplug all connectors.
- 2) Undo all the thumb screws on the rear case, store them safely and remove the back panel
- 3) Locate the main option board, which will be similar in appearance to the diagram below. If a main option board is absent, which will be the case if the display was ordered without any output options, then a main option board will need to be fitted.

The board assemblies will look like this...

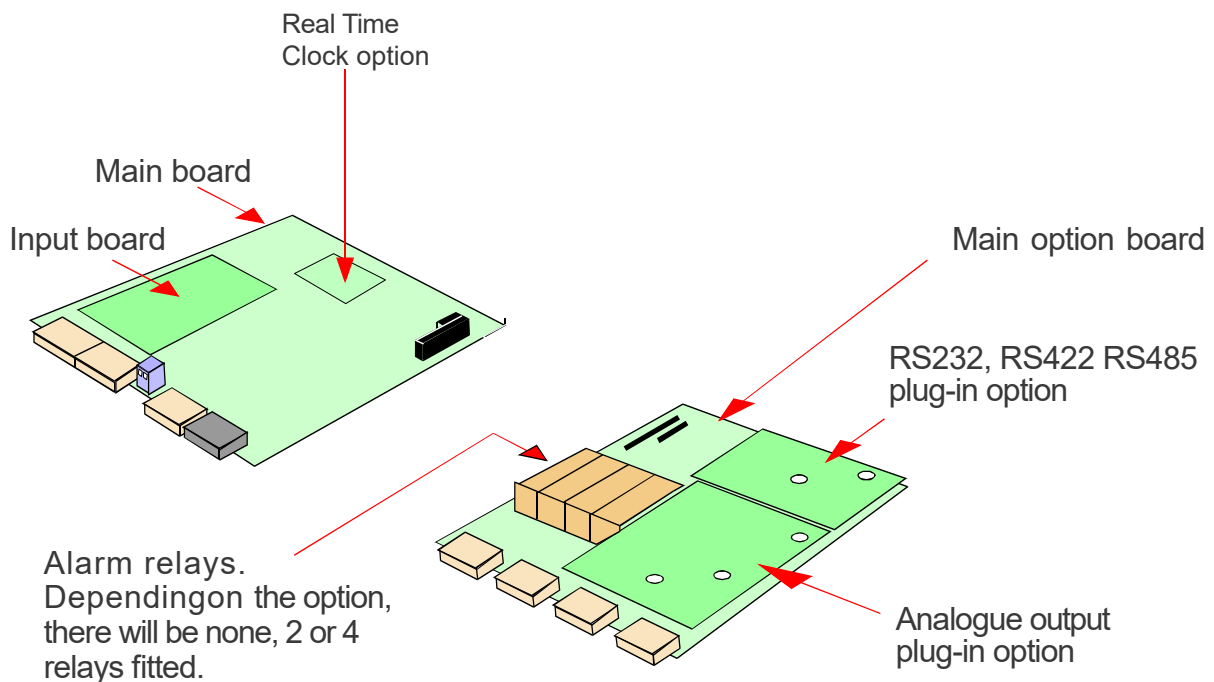

The analogue output and RS232 or RS422 plug-in option boards are fixed to the main option board with white plastic pillars. You must apply a firm force when fitting or removing these options.

Always be careful to connect the pins to sockets accurately. When reassembling, make sure option boards are firmly fixed to the upper option board.

Waste Electrical Electronic Equipment (WEEE)

In Europe, this equipment must be disposed of in accordance with European parliamentary Directive 2002/96/EC

This directive encourages recycling and the reduction of waste materials in the environment.

This means it must be sent to an approved recycling plant if you want to dispose of it.

It must not be thrown away with general rubbish.



WEEE Waste Recycling

If you are unable to dispose of this item locally, you may send it to us for recycling.

Conditions:

1. We will only accept items of our manufacture.
2. You must pay for the transport of the goods to us.
3. We will only accept items if they include a signed declaration by an authorised person in your organisation, stating that :-
 - i. The item is safe to handle and has no contaminants which may be harmful to health.
 - ii. You wish us to dispose of or destroy the item(s)

Equipment Specifications

TECHNICAL DATA									
Digit Height (inches)	2	4	6	8	12	16	24	32	48
Digit Height (mm)	57	102	150	200	300	400	600	800	1200
Viewing Distance (feet)	75	150	225	300	450	600	900	1200	1800
Viewing Distance (metres)	25	50	75	100	150	200	300	400	600
Number of Digits	4 or 6								
Digit Format	8.8.8.8., 8.8.8.8.8.8.								
Input Signal	Process (0-20mA, 4-20mA, 0-10V, 1-5V)								
Accuracy	+/- 0.05% of range								
Excitation Voltage	24V @ 30mA								
Digit Colour	Blue, green, red, yellow, white								
Brightness	Indoor or outdoor with 7 levels of adjustment								
Power Supply	95-265V AC (standard), 11-30V DC (optional), 48V AC (optional)								
Power Burden	40VA maximum								
Mounting	Brackets supplied for wall, suspension or panel mounting								
Front Panel Controls	Up to 200mm high digits, above 200mm high digits requires an optional wired or wireless controller								
Logic Inputs	3 x NPN or contact closure for TARE, PEAK/VELLEY and RESET								
Environmental									
Enclosure Material	Heavy duty welded uPVC								
Lens Material	Acrylic								
Sealing	IP65								
Storage Temperature	-20°C to +70°C, non-condensing								
Operating Temperature	0°C to 50°C, non-condensing								
Extended Operating Temperature	-25°C to 50°C, non-condensing (with optional heater fitted inside display)								
Connectors	Internal detachable screw terminal connectors accessed via compression glands								
Analogue Output (optional)									
ANB Option	-10 to +10V into loads > 1K Ohms, resolution 0.4mV								
ANI Option	0-20mA or 4-20mA into loads <500 Ohms, resolution 0.4uA								
ANV Option	0-10V into loads > 1K Ohms, resolution 0.2mV								
Scaling	Fully adjustable, direct or inverse. Can be derived from GROSS or NETT value								
Response Speed	Derived from displayed value, updated x10 per second, display filtering applies to analogue output								
Linearisation	Derived from displayed value								
Isolation	250V AC optically isolated from input, logic, excitation, power, alarms and data output ports								
Accuracy	+/- 0.1% of range								
Linearity	+/-0.02% of range								
Stability	+/- 50ppm/°C								
Alarm Output (optional)									
AL2 and AL4 Option	2 or 4 x SPST mechanical relays, 2A @ 250V AC, resistive load								
DSS and QSS Option	2 or 4 x SPST solid state relays, specify AC or DC, 100mA max @250V AC, 500mA max @ 60V DC								
SPCO Option	2 x SPCO mechanical relays, 2A @250V AC, resistive load								
Response Speed	For mechanical relays allow 105mS, for solid state relays allow 100mS								
Data Output (optional)									
232 Option	RS232 ASCII								
485 Option	RS422/RS485 ASCII + Modbus ASCII								
RTU Option	Modbus RTU								
Response Speed	Derived from displayed value, updated x10 per second, display filtering applies to data output								
Isolation	250V AC optically isolated from input, logic, excitation, power, alarms and analogue output ports								

Record of Revisions

6 September 2010	Version F0.18 Software released. Manual format revised to improve clarity and segregate easy from advanced menu functions. Optional outputs now described in their own dedicated manuals. DIN Rail mounting option added. Cabling guidance added.
17 November 2010	Version F00.19 Software released. Intended for use with 9122-2470 input board, having switched capacitor input filter feature. Code will auto detect this board. If a previous version board is installed, the meter will skip switched capacitor filter section of menu. The newly released 9122-2470 input board allows 5V,10V or 24V excitation.
26 November 2010	Version F00.20 Software released. Allows serial data output to derived from Net or Gross measurement on full featured FX-XN-P versions
2 February 2011	Version F00.21 software released. New boot-up routine added for LED testing.
28 February 2011	Warranty increased to 3 years and terms added.
30 August 2011	Corrected Remote Programmer connection details.
30 July 2014	Version F00.23 software released and V4 input board with active filter described
21 January 2016	Mounting dimensions amended for flush case bosses
10 February 2017 rate.	F4.01 software released, plus V4 input board with selectable active filter
13 March 2019	Input resistance changed to 2.000 Ohms for 4-20mA
20 September 2022	UKCA certification added
20 June 2024	Backing screws changed to 'M3x8 Socket Flange Button Head Screws'

Declaration of UK & CE Conformity



Declaration Reference : INTUITIVE Mk4
 Issue Date : 20 September 2022
 Products Covered : INTUITIVE Mk4 series
 Title : DOC-INTUITIVE4

We hereby self-certify that the design and manufacture of this product conforms with the UKCA and CE standards, by complying with the directives and standards below.

Electrical Equipment (Safety) Regulations, 2016 and amendments Low
 Voltage Directive 2014/35/EU
 BS EN 61010-1 : 2010 + A1 : 2019

Electromagnetic Compatibility Regulations, 2016 and amendments
 EMC Directive 2014/30/EU
 EN 61326-1 : 2013
 Immunity for equipment intended to be used in an industrial electromagnetic environment.

Maximum errors of 1% of dynamic range are permitted.
 Instrument must recover automatically from disturbance.

Restriction of the Use of Certain Hazardous Substances in Electrical and Electronic Equipment
 Regulations, 2012 and amendments
 RoHS2 directive incorporating RoHS3 Amendment 2015/863/EU
 EN IEC 63000 : 2018

Conditions

The meters are permitted a worst case error of 1% of A/D range during electro-magnetic disturbance, and must recover automatically when disturbance ceases without the need for human intervention, such as resetting, power-down etc.

The meters covered by this certificate must be installed in adherence to the following conditions :-

Signal cabling shall be routed separately to power carrying cabling (includes relay output wiring)

All signal cabling shall be screened. The screen shall only be terminated to the power earth terminal at the meter end of the cable.

Declared as true and correct, for and on behalf of London Electronics Ltd.

J.R.Lees Director