

London Electronics Limited

Thorncote Road, Near Sandy, Bedfordshire SG19 1PU
Tel +44(0)1767 626444 Fax +44(0)1767 626446
www.london-electronics.com help@london-electronics.com

Models LOAD-3 & LOAD-4 series

3 1/2 and 4 1/2 digit Loadcell panel meters with optional outputs

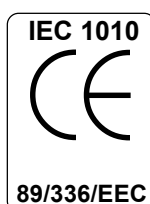

VERY IMPORTANT WARNINGS



You should carefully read all warnings and commence installation ONLY when you are satisfied that all warnings are adequately covered.



} Connections to this equipment shall be carried out in accordance with current IEE regulations, and all wiring shall be separated in accordance with IEC1010

Notes:

} Power supplies to this equipment must be anti-surge fused at 125mA for 230V supply, 250mA for 110V supply or 630mA for DC supplies in the range 12-30VDC

Notes:

} Before installation, check that model number and supply voltage suit your application

Notes:

} Lethal voltages may be present on the circuit board. Do not touch any circuitry when power is applied.

Notes:

} This product is designed for Installation class II service

Notes:

} This product is designed for use in Pollution-Degree 2 environments

Notes:

} Use an insulated screwdriver when adjusting potentiometers and do not touch any circuitry

Notes:

} Replace front cover when meter is unattended

Notes:

} All adjustments to jumper settings or terminations must be made with power removed

Notes:

} Ensure all screw terminals are tight before applying power.

Notes:

***Safety FirstDon't make assumptions..... Always double check.
If in doubt, ask someone who is QUALIFIED to assist you in the subject.***

TABLE OF CONTENTS

- 1) Introduction
- 2) Specifications
- 3) Panel Requirements + Connections
- 4) Alarm + Retransmission Option
- 5) Adjustments + Calibration
- 6) BCD O/P option
- 7) RS232 O/P option
- 8) Declaration of Conformity

IMPORTANT INTRODUCTORY NOTES

Thank you for choosing to use a London Electronics Ltd. product. We hope that you will be entirely satisfied with your purchase, and welcome any comments you may have which will help us to improve the ease of use, clarity of this manual, etc. for future shipments.

We invite you to write to us, free of charge, if posted in the United Kingdom, to:-

**London Electronics Ltd.
Customer Services Department
Thorncote Road
Near Sandy
Bedfordshire SG19 1PU
England**

Alternatively you may send us a fax on **01767-626444** (international code +44)
Or, telephone us on **01767-626446** (international code +44)

Or, send us an E-Mail to **help4u@london-electronics.com**

To enable us to provide a swift and accurate service, please be sure to provide the following information :-

- 1) Full Model Number , including all options fitted.
- 2) Serial Number
- 3) DETAILED description of your difficulties, suggestions etc.
- 4) Input Range and Display range

This product is covered by a 2 year warranty, during which period we will put right or replace any meter found to be faulty through bad workmanship or materials. This warranty does not cover damage caused by misuse or accident.

IMPORTANT If the meter is a vital component in your process, you may wish to consider the purchase of a spare to cover the possible eventuality of a failure or accident, as we cannot guarantee instant repair or replacement.

We are constantly striving to improve our products and services, and as a result, changes to instruments do occur. Please ensure that this manual is kept safely for future reference, as future manuals, covering revised designs may no longer describe your product accurately.

We believe these instructions to be accurate, and the product to be competently designed and manufactured. We do not make any claims as to the suitability of this product for any particular application. The choice of product and responsibility for the choice lies with the User.

EQUIPMENT SPECIFICATIONS

Input Signal	0-25mV 0-100mV
Input Resistance.....	1.1M 1.1M
Resolution.....	1 in 2000 for LOAD3 meters, 1 in 20000 for LOAD4 meters
CMRR.....	70 dB DC to 450 Hz.
NMRR.....	56 dB 45 to 10000 Hz.
Open Circuit Input Response...	Downscale Drive
Speed of Response.....	Display = 2.5/sec. <i>See separate sections below for analogue & alarm speeds</i>
Decimal Point Selection.....	Push-on Jumpers
Accuracy.....	0.05% of reading
Temperature stability.....	50 ppm of range/C span and zero
A/D Technique.....	Dual Slope integration
Conversion Rate.....	2 1/2 conversions per second (every 400 mS)
Integration Time.....	100 mS
 Display	 High brightness LED
Digit Height.....	14.2mm 0.56"
Digit Colour.....	Red as standard, optionally green
 Excitation Supply	 Selectable 10 or 24VDC, regulated. Others possible, including constant current.
Accuracy.....	+/-5% accuracy. Stability is 50ppm/C
Current Capacity.....	120mA for 10V, 30mA for 24V
 Power Supply	
AC Supply.....	110 or 230 VAC as standard. 24VAC optional Others possible on request
DC Supply.....	10 to 30 VDC as an option. Also 5V +/-5%.
Current Consumption.....	Allow 8VA if all options fitted & excitation supply fully loaded.
 Mechanical	
Bezel Size.....	48mm high by 96mm wide
Cutout Size.....	45 mm high by 92 mm wide
Depth behind Panel.....	125 mm
Weight.....	550 grammes typically
Case Material.....	UL 94V0 rated black ABS
 Environmental	
Operating Temperature.....	-.20 to +50 degrees C
Storage Temperature.....	-40 to +85 degrees C
Humidity.....	90% rh max. at 40 C, non condensing.
 Analogue O/P Option	
Drive Capacity.....	4-20mA into loads 0 - 500 Ohms. 0-10 V into loads from 500 Ohms to Infinity
Isolation.....	380V safety rated from power & earth, but not isolated from input stage
Speed of Response.....	Standard = 500 milliseconds. Optionally with 1 millisecond (option = FAST)
Accuracy.....	0.05% of range
Linearity.....	0.01% of range
 Alarm O/P Option	
Format.....	Changeover relay, 2 off, settable as HIGH or LOW. De-energise on alarm - failsafe
Current Rating.....	7 amperes, resistive. If driving inductive loads, MOV varistors are recommended
Voltage Rating.....	250VAC, 24VDC
Speed of Response.....	Standard = 15mS. Can provide solid state alarms with 5mS response speed.
Hysteresis.....	Typically 4 counts
Annunciation.....	Red LED illuminates when relay de-energises
Setting Method.....	Pushbutton allows alarm point to be viewed. Alter with coarse & fine potentiometers
 BCD O/P Option	
Format.....	Multiparallel, isolated, addressable tri-state. Presented on 50 way male IDC header
Data Levels.....	12VDC up to 24VDC. Level is derived from power applied to BCD port
Response speed.....	Data available 5 milliSeconds after request. Data updated every 400mS
 Serial Data O/P Option	
Baud Rate.....	Selectable 300, 600, 1200, 2400, 4800 or 9600
Addressing.....	32 addresses available
Format.....	1 start bit, 8 data bits, 1 or more stop bits. ASCII data terminated with a carriage return
Connections.....	4 way detachable screw terminal connector

PANEL REQUIREMENTS



All wiring to this meter must be carried out in accordance with current IEC regulations
Separation of all power carrying cables must be ensured in accordance with IEC 1010

Installation Class II
Pollution degree 2



This meter is to be installed within a secure enclosure, to prevent accidental access by persons to the powered connections present on the meter's rear terminals.

CUTOUT DIMENSIONS

A hole 45 mm high and 92 mm wide, with minimal radius is required

Connections

Connector Specifications :- [VDE Rated Voltage, group B insulation VAC = 380]-[VDE Rated Current = 8 Amperes.]
[Vibration Immunity per VDE0611 <10g]-[Rated Number of mating cycles <100]-[Screw Clamp material/plating Steel/ZnCc]
[Contact Spring material/plating CuSN/gal SnPb]-[Plug-in force, per pole is from 3 to 6 Newtons]-[Disconnect force per pole is from 4 to 7 Newtons]-[Screw clamp tightening torque recommended 0.5Nm]-[Solid wire csa between 0.13 to 1.5mm²]
[Multistrand wire csa from 0.5 to 1.5mm²]-[AWG conductor range from 22 to 16]-[Gauge to DIN/EN50027 Size A1]

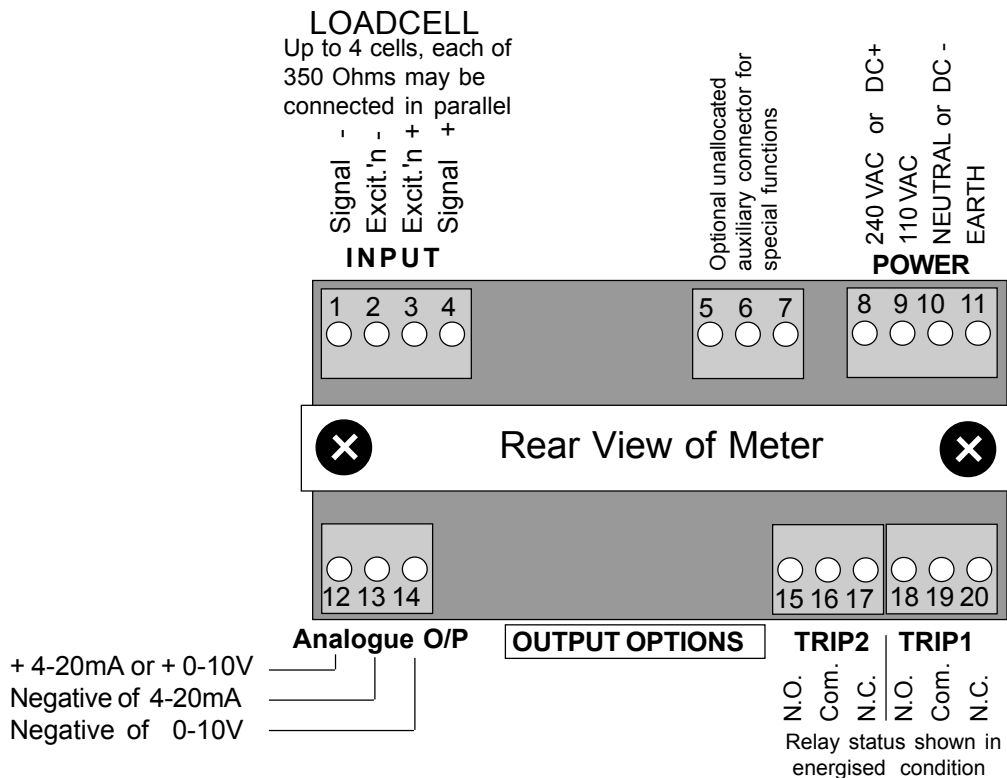

Please see appropriate section in this manual for connection details of BCD option or SERIAL output options. These options are mutually exclusive, and are not available with Analogue output or Trip output options.

AVOID DISAPPOINTMENT! Route **all** signals via individually screened cables. Do **not** mix input and output signals in the same screened cable. Earth the screens at a point as near to the meter as possible and do not earth the screen at the other end. Route all signal cables well away from power cables, relay switching cables and other sources of electrical noise.

ALARM & ANALOGUE O/P SETTINGS

This board is located below the display. You will only need to remove the board from the case if you wish to change the analogue output from 4-20mA to 0-10V. The board is supplied as 4-20mA default, unless you specifically ordered the unit to have 0-10V output.

To change trip action or adjust trip points, simply unclip the lens from the display, which will allow access to the jumpers and potentiometers.

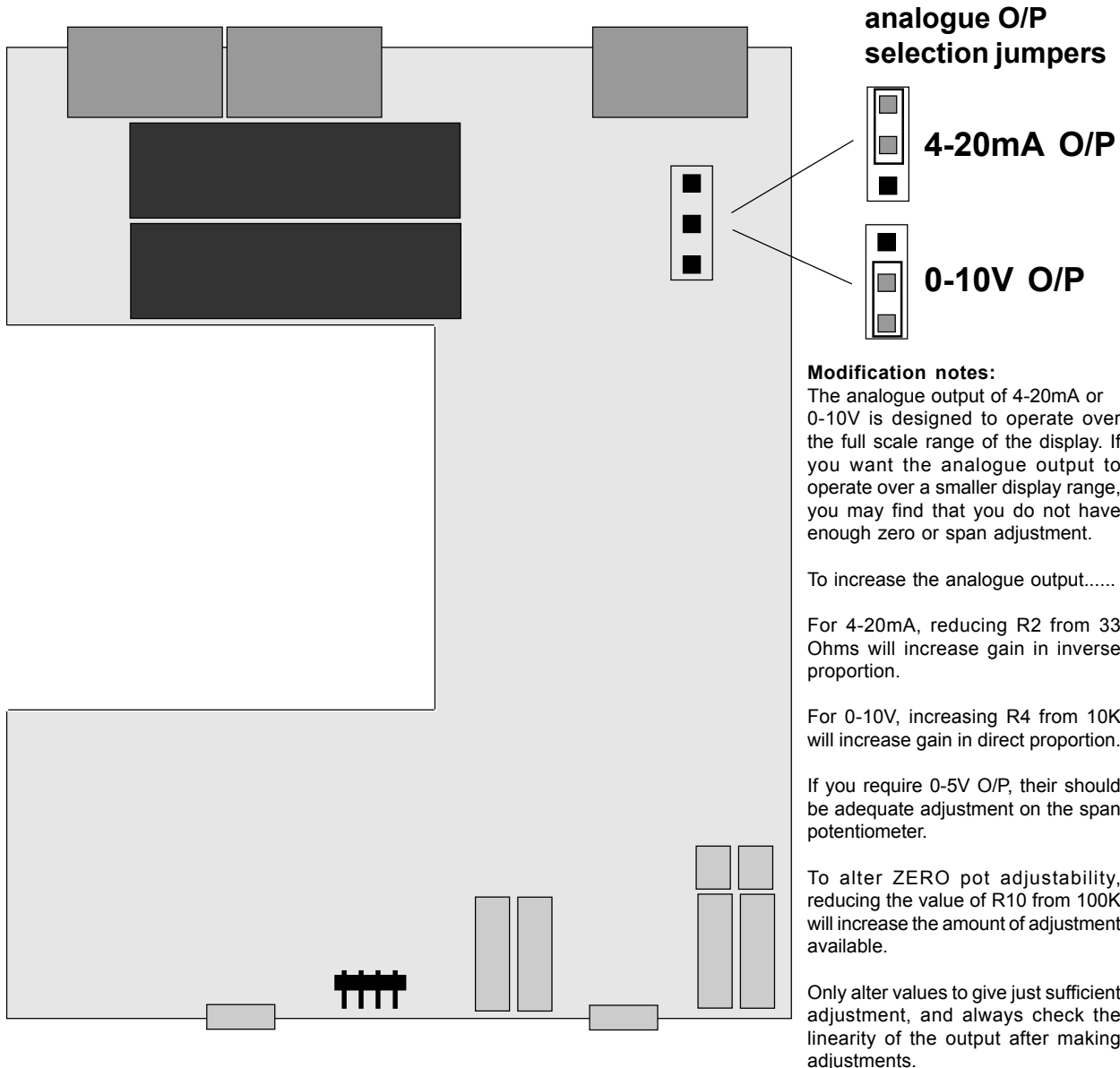

Modification notes:
 The analogue output of 4-20mA or 0-10V is designed to operate over the full scale range of the display. If you want the analogue output to operate over a smaller display range, you may find that you do not have enough zero or span adjustment.

To increase the analogue output.....
 For 4-20mA, reducing R2 from 33 Ohms will increase gain in inverse proportion.
 For 0-10V, increasing R4 from 10K will increase gain in direct proportion.

If you require 0-5V O/P, there should be adequate adjustment on the span potentiometer.

To alter ZERO pot adjustability, reducing the value of R10 from 100K will increase the amount of adjustment available.

Only alter values to give just sufficient adjustment, and always check the linearity of the output after making adjustments.

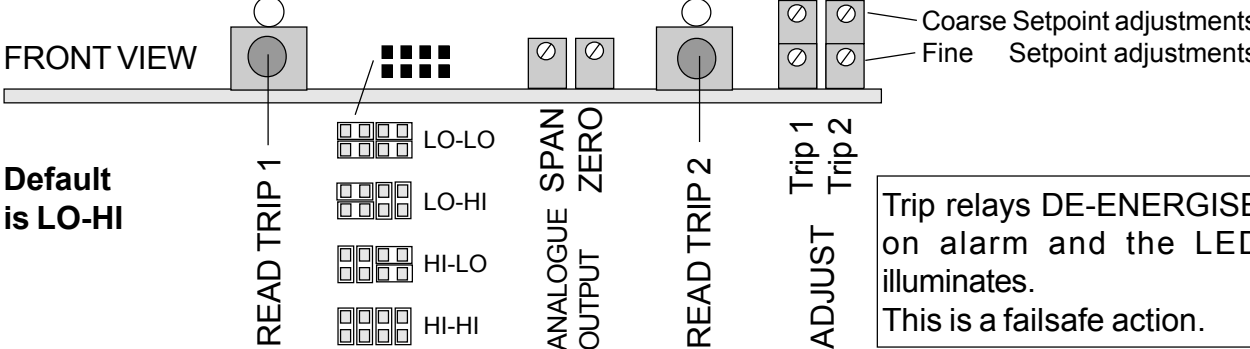

Trip relays DE-ENERGISE on alarm and the LED illuminates. This is a failsafe action.

BCD-OUTPUT OPTION SETTINGS

This output option board is located below the display. You will only need to remove the board from the case if you wish to change the board's address. The board is supplied set to address 01 as default.

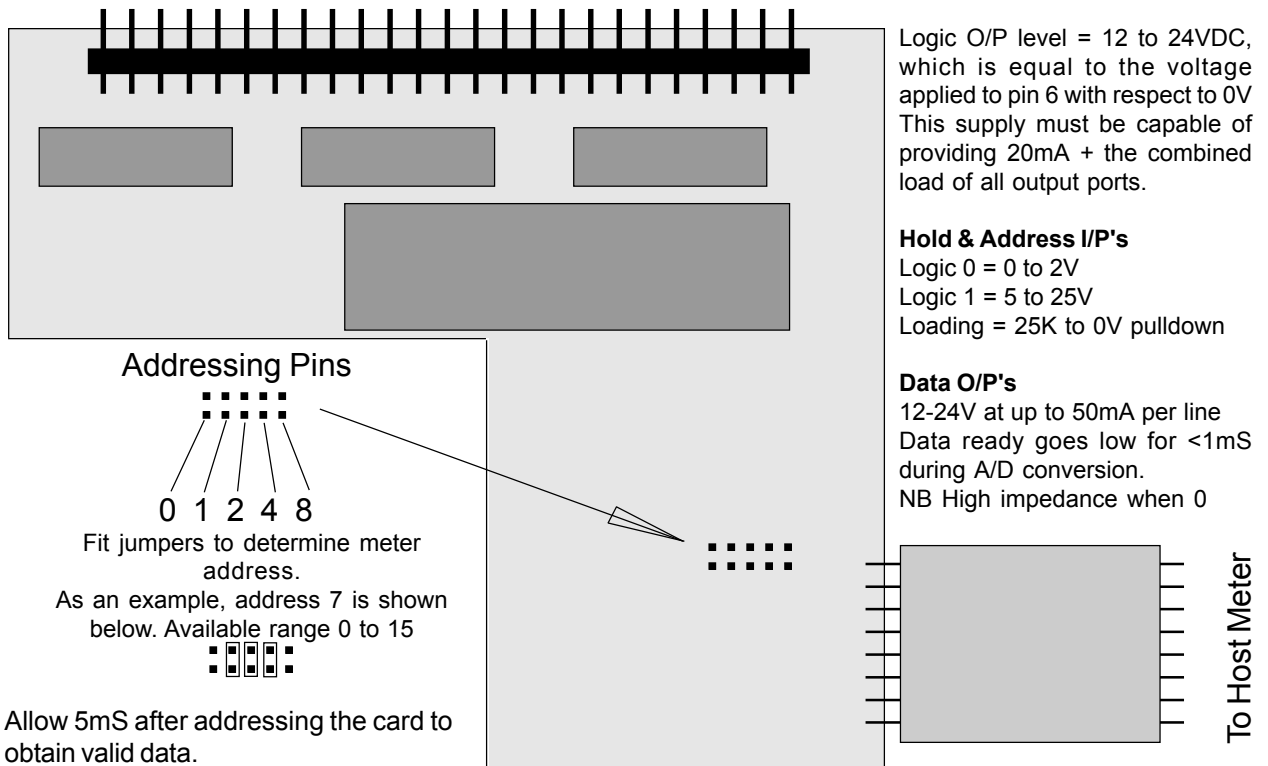

Allow 5mS after addressing the card to obtain valid data.

This option derives its data directly from the meter's A/D convertor. This data is updated every 400 milliseconds, but can be accessed within 5 milliseconds. The outputs and handshake lines are fully isolated from the meter to a level of 380 VAC. The option must be powered externally, typically from your PLC accessory supply.

The data output weighting of 1,2,4,8, ...10K corresponds to 4 1/2 digit meters. For 3 1.2 digit meters, divide the given values by 10. The addressing weighting will be identical for 3 1/2 and 4 1/2 digit meter types.

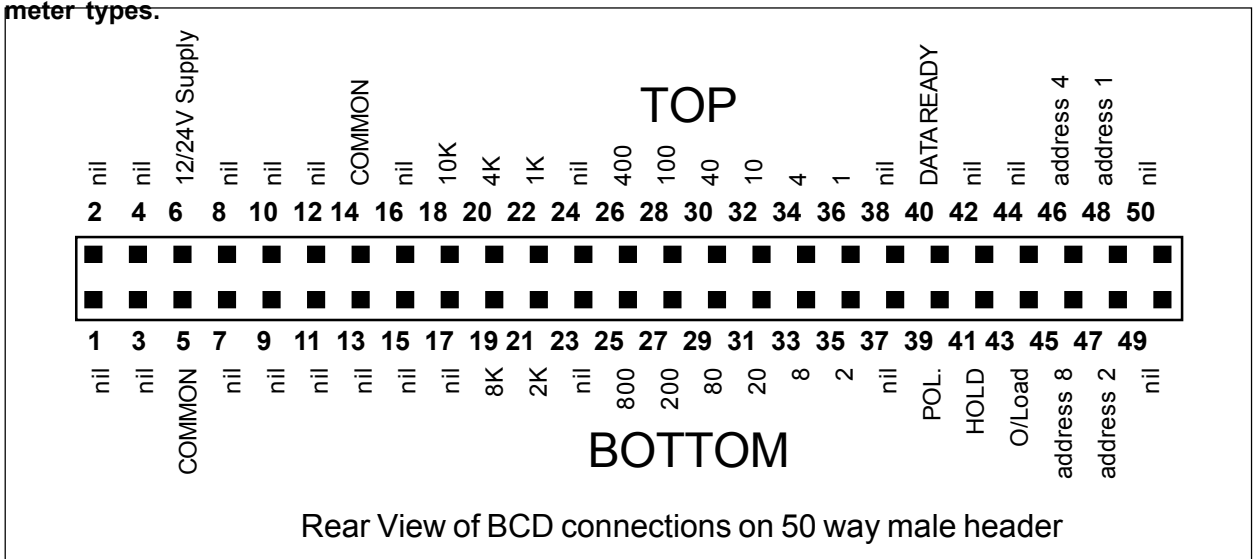

RS232 OUTPUT OPTION

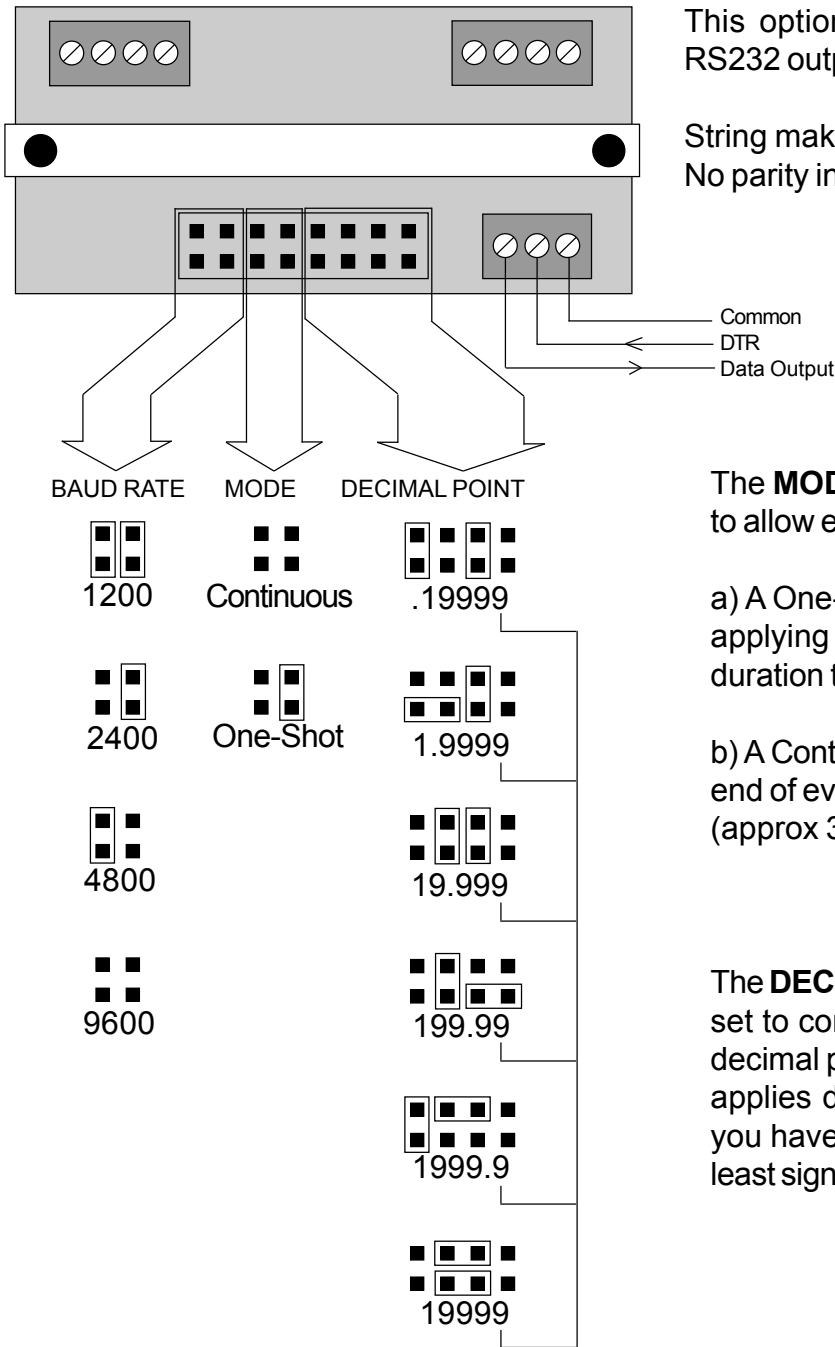

This option board provides an isolated RS232 output in ASCII format .

String makeup is 1 Start, 8 Data,1 Stop
No parity information is provided.

The **MODE** jumpers should be selected to allow either:-

a) A One-Shot transmission, enabled by applying a +5V signal of at least 10mS duration to the DTR input, or ...

b) A Continuous transmission, sent at the end of every A/D conversion cycle (approx 3 times per second)

The **DECIMAL POINT** jumpers should be set to correlate with the display jumper decimal point setting. The format shown applies directly to 4 1/2 digit meters. If you have a 3 1/2 digit meter, ignore the least significant digit in the table opposite.

Notes

Declaration of Conformity

Declaration Number : LOAD Iss. 2
Issue Date : 21 April 1997
Products Covered : LOAD-3 & 4 series
Title : DOC-LOAD

This is to confirm that the Products covered by this declaration have been designed and manufactured to meet the following specifications :

EN55022:1987 Conducted Emissions: Class B
EN55022:1987 Radiated Emissions : Class B
IEC801-2:1984 Electro-Static Discharge Immunity: 8kV Air
IEC801-3:1984 Radiated ElectroMagnetic field Immunity: 3V/m
IEC801-4:1988 Fast Transient Immunity : AC 1kV, cable 0.5kV

Thus the products conform with the applicable sections of the following standards:

EN50081-1:1992 (normative)
EN50082-1:1992 (normative)

and comply with the requirements of Council Directive 89/336/EEC relating to Electro-Magnetic Compatibility, & are designed to meet 72/23/EEC safety directive.

To confirm EMC compliance, representative models within the range have been independently tested and certified by MARCONI INSTRUMENTS EMC Department.

MARCONI CERTIFICATE # : TC95/0074C
MARCONI CERTIFICATE Issue # : 1
MARCONI Certificate Issue Date : 3 July 1995

Conditions

The meters are permitted a worst case error of 1% of A/D range during electro-magnetic disturbance, and must recover automatically when disturbance ceases without the need for human intervention, such as resetting, power-down etc.

The meters covered by this certificate must be installed in adherence to the following conditions :-

Signal cabling shall be routed separately to power carrying cabling (includes relay output wiring)
All signal cabling shall be screened. The screen shall only be terminated to the power earth terminal

This certificate applies only to meters carrying Serial Numbers 701001 or higher.

Signed as true and correct, for and on behalf of London Electronics Ltd.

.....
J.R. Lees Director