

# *London Electronics Limited*

Warren Court, Chicksands, Shefford, SG17 5QB, England

Tel: 01462 850967 Fax: 01462-850968 International prefix +44

E-Mail [help@london-electronics.com](mailto:help@london-electronics.com)

Web site with news, distribution details, product descriptions <http://www.london-electronics.com>

## Operating Instructions

### **MICRO-LITE-P**

***Miniature Programmable Process meter  
with alarm and retransmission options***

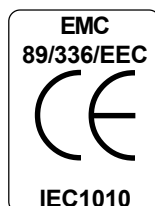

These instructions cover product with serial numbers from 701001

Document Ref:MICLITE

Revision:1

Dated:6/2/98

# ***TABLE OF CONTENTS***

- 1) Very Important Warnings 
- 2) Important Introductory Notes
- 3) Equipment Specifications
- 4) Panel requirements & Connection Details
- 5) Adjustments and Calibration
- 6) Special Menu Section
- 7) Alarm 1 & 2 setup menu
- 8) Analogue O/P menu
- 9) Printer Port menu
- 10) Peak, Tare & Password menus
- 11) Setting Alarm Levels
- 12) Declaration of Conformity

# VERY IMPORTANT WARNINGS



**You should carefully read all warnings and commence installation ONLY when you are satisfied that all warnings are adequately covered.**



! Connections to this equipment shall be carried out in accordance with current IEE regulations, and all wiring shall be separated in accordance with IEC1010

Notes:

! Power supplies to this equipment must be anti-surge fused at 125mA for 230V supply, 250mA for 110V supply

Notes:

! Before installation, check that model number and supply voltage suit your application

Notes:

! Lethal voltages may be present on the circuit board. Do not touch any circuitry when power is applied.

Notes:

! This product is designed for Installation class II service

Notes:

! This product is designed for use in Pollution-Degree 2 environments

Notes:

! Use an insulated screwdriver when adjusting potentiometers and do not touch any circuitry

Notes:

! Replace front cover when meter is unattended

Notes:

! All adjustments to jumper settings or terminations must be made with power removed

Notes:

! Ensure all screw terminals are tight before applying power.

Notes:

***Safety First .....Don't make assumptions..... Always double check.  
If in doubt, ask someone who is QUALIFIED to assist you in the subject.***

# **IMPORTANT INTRODUCTORY NOTES**

Thank you for choosing to use a London Electronics Ltd. product. We hope that you will be entirely satisfied with your purchase, and welcome any comments you may have which will help us to improve the ease of use, clarity of this manual, etc. for future shipments.

We invite you to write to us, free of charge, if posted in the United Kingdom, to:-

**London Electronics Ltd.  
Customer Services Department  
FREEPOST SG334  
SHEFFORD  
Bedfordshire SG17 5BR**

Alternatively you may send us a fax on **01462-850968** (international code +44)

Or, telephone us on **01462-850967** (international code +44)

Or, send us an E-Mail to **help4u@london-electronics.com**

To enable us to provide a swift and accurate service, please be sure to provide the following information :-

- 1) Full Model Number , including all options fitted.
- 2) Serial Number
- 3) DETAILED description of your difficulties, suggestions etc.
- 4) Input Range and Display range

This product is covered by a 2 year warranty, during which period we will put right or replace any meter found to be faulty through bad workmanship or materials. This warranty does not cover damage caused by misuse or accident.

**IMPORTANT** If the meter is a vital component in your process, you may wish to consider the purchase of a spare to cover the possible eventuality of a failure or accident, as we cannot guarantee instant repair or replacement.

We are constantly striving to improve our products and services, and as a result, changes to instruments do occur. Please ensure that this manual is kept safely for future reference, as future manuals, covering revised designs may no longer describe your product accurately.

We believe these instructions to be accurate, and the product to be competently designed and manufactured. We do not make any claims as to the suitability of this product for any particular application. The choice of product and responsibility for the choice lies with the User.

# EQUIPMENT SPECIFICATIONS

**Input Signal**.....0/4-20mA      0-10V      1-5V      0-5V ... others possible  
Input Resistance.....<20 Ohms      1.1M      1.1M      1.1M  
Resolution.....1 in 9999  
CMRR.....70 dB DC to 450 Hz.  
NMRR.....60 dB 45 to 60 Hz.  
Open Circuit Input Response.....Downscale Drive for current  
Speed of Response.....Display = 0.2, 0.4 or 0.8 Seconds  
Decimal Point Selection.....Programmable  
Accuracy.....0.03% of reading  
Temperature stability.....50 ppm of range/C span and zero  
A/D Technique.....Dual Slope integration  
Conversion Rate......5, 2 1/2 or 1 conversions per second, selectable  
Integration Time.....100 mS

**Display** .....High brightness LED  
Digit Height.....14.2mm 0.56"  
Digit Colour.....Red

**Excitation Supply**.....Selectable 24VDC, regulated. Others possible, including constant current.  
Accuracy.....+/-5% accuracy. Stability is 50ppm/C  
Current Capacity.....35 mA

**Power Supply**  
AC Supply.....90 to 265 VAC as standard.  
DC Supply.....Not catered for  
Current Consumption.....Allow 4VA if all options fitted & excitation supply fully loaded.

**Mechanical**  
Bezel Size.....24 mm high by 72 mm wide  
Cutout Size.....22 mm high by 68 mm wide  
Depth behind Panel.....125 mm  
Weight.....550 grammes typically  
Case Material.....UL 94V0 rated cream ABS

**Environmental**  
Operating Temperature.....-10 to +60 degrees C  
Storage Temperature.....-40 to +85 degrees C  
Humidity.....90% rh max. at 40 C, non condensing.

**Analogue O/P Option**  
Drive Capacity.....4-20mA into loads 0 - 500 Ohms. 0-10 V into loads from 500 Ohms to Infinity  
Isolation.....380V safety rated from power & earth, and input  
Speed of Response.....Standard = 500 milliseconds.  
Accuracy.....0.1% of range  
Linearity.....0.1% of range

**Alarm O/P Option**  
Format.....SPST relay, 2 off, settable as HIGH or LOW.  
Current Rating.....5 amperes, resistive. If driving inductive loads, MOV varistors are required  
Voltage Rating.....250VAC,  
Speed of Response.....Standard = 200mS.  
Hysteresis.....Adjustable 0-8000 counts  
Annunciation.....Red LED illuminates  
Setting Method.....Pushbutton

**BCD O/P Option**  
Format.....Not available  
Data Levels.....  
Response speed.....

**Serial Data O/P Option**  
Baud Rate.....Selectable 300, 600, 1200, 2400, 4800 or 9600  
Addressing.....None ... output only  
Format.....1 start bit, 8 data bits, 1 or more stop bits. ASCII data terminated with a CR  
Connections.....Common and TXD

# PANEL REQUIREMENTS



All wiring to this meter must be carried out in accordance with current IEC regulations  
Separation of all power carrying cables must be ensured in accordance with IEC 1010

Installation Class II  
Pollution degree 2



This meter is to be installed within a secure enclosure, to prevent accidental access by persons to the powered connections present on the meter's rear terminals.

## CUTOUT DIMENSIONS

A hole mm high and mm wide, with minimal radius is required

# Connections

**Connector Specifications :-** [VDE Rated Voltage, group B insulation VAC = 380]-[VDE Rated Current = 8 Amperes.]  
[Vibration Immunity per VDE0611 <10g]-[Rated Number of mating cycles <100]-[Screw Clamp material/plating Steel/ZnCe]  
[Contact Spring material/plating CuSN/gal SnPb]-[Plug-in force, per pole is from 3 to 6 Newtons]-[Disconnect force per pole is from 4 to 7 Newtons]-[Screw clamp tightening torque recommended 0.5Nm]-[Solid wire csa between 0.13 to 1.5mm<sup>2</sup>]  
[Multistrand wire csa from 0.5 to 1.5mm<sup>2</sup>]-[AWG conductor range from 22 to 16]-[Gauge to DIN/EN50027 Size A1]

## Rear View of Meter

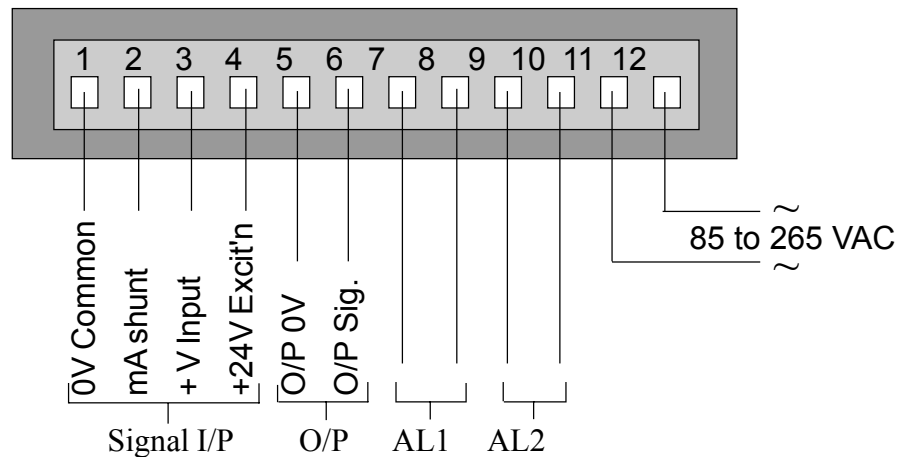

For 4-20mA and other current I/P's, take + to pins 2 & 3. Take - to pin 1

For 4-20mA 2 wire transmitters, take + of transmitter to pin 4, take - to pins 2 & 3, 1 is unused

For Voltage inputs, take + to pin 3, - to pin 1

The output signals on terminals 5 & 6 will either be analogue output or RS232 output, depending on which option has been fitted.

The alarm outputs are rated at 5 Amperes, 240 VAC or 1 Ampere 24VDC. They are designed to switch resistive loads only. If you wish to switch inductive loads, you should fit MOV type suppressors across the inductive load to clamp the high back EMF which will occur when the contacts open, and which would otherwise result in premature contact failure.

**IMPORTANT:** Do not run signal wires near any power-carrying cables. Power-carrying cables will almost certainly radiate appreciable amounts of electro-magnetic energy, which could interfere with the small signals you are trying to measure. Use screened cable, in its own separate conduit or tray. Connect the screen to a clean earth point as near to the meter as possible.

# ADJUSTMENTS & CALIBRATION

Press both buttons together to enter the SETUP menu. (Use the side of your thumb to press both buttons )  
 To move down the menu stack, press the lower button, to move to the right, press the upper button

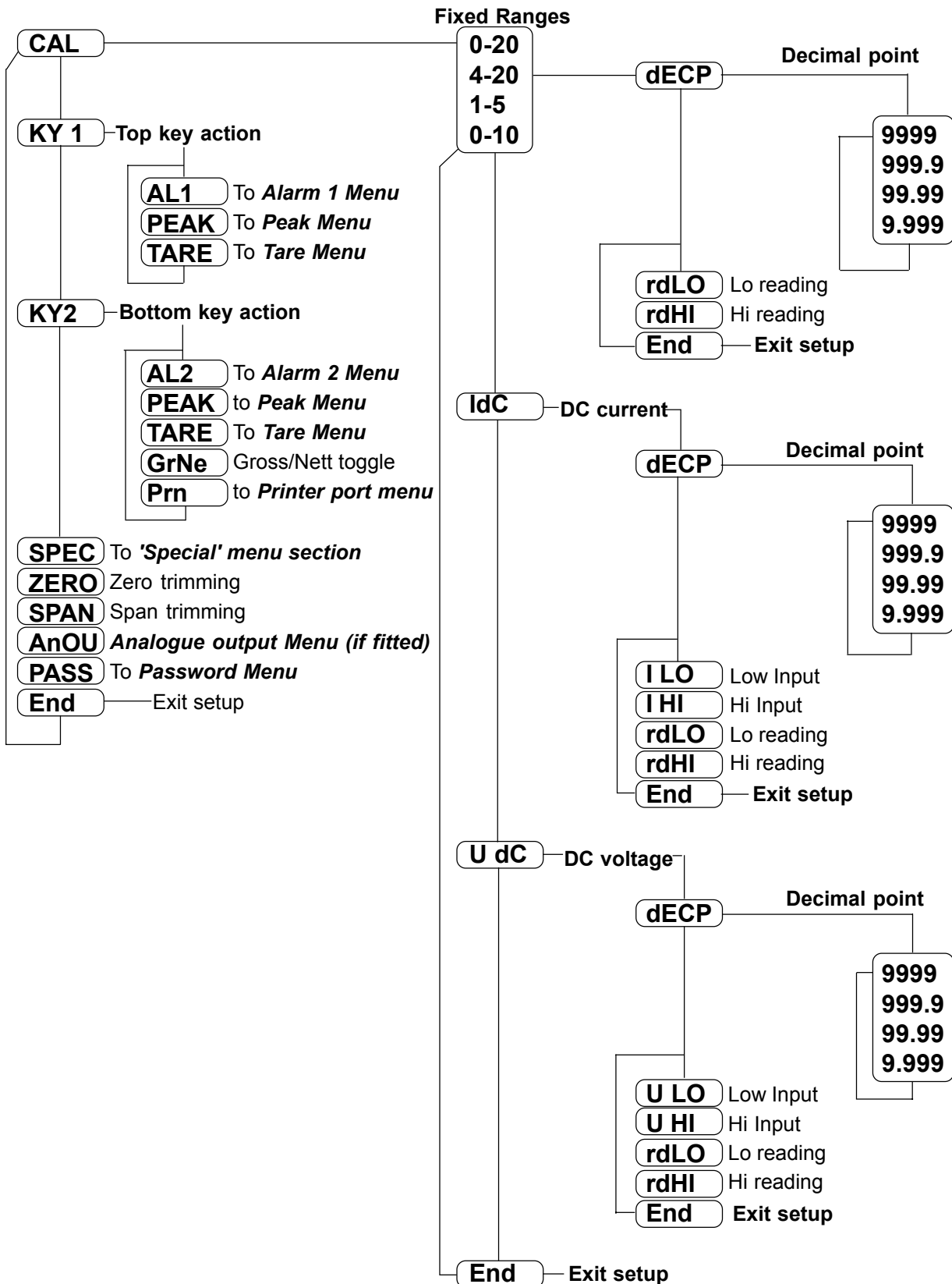

# 'SPECIAL' MENU SECTION

From Main Menu on p5...

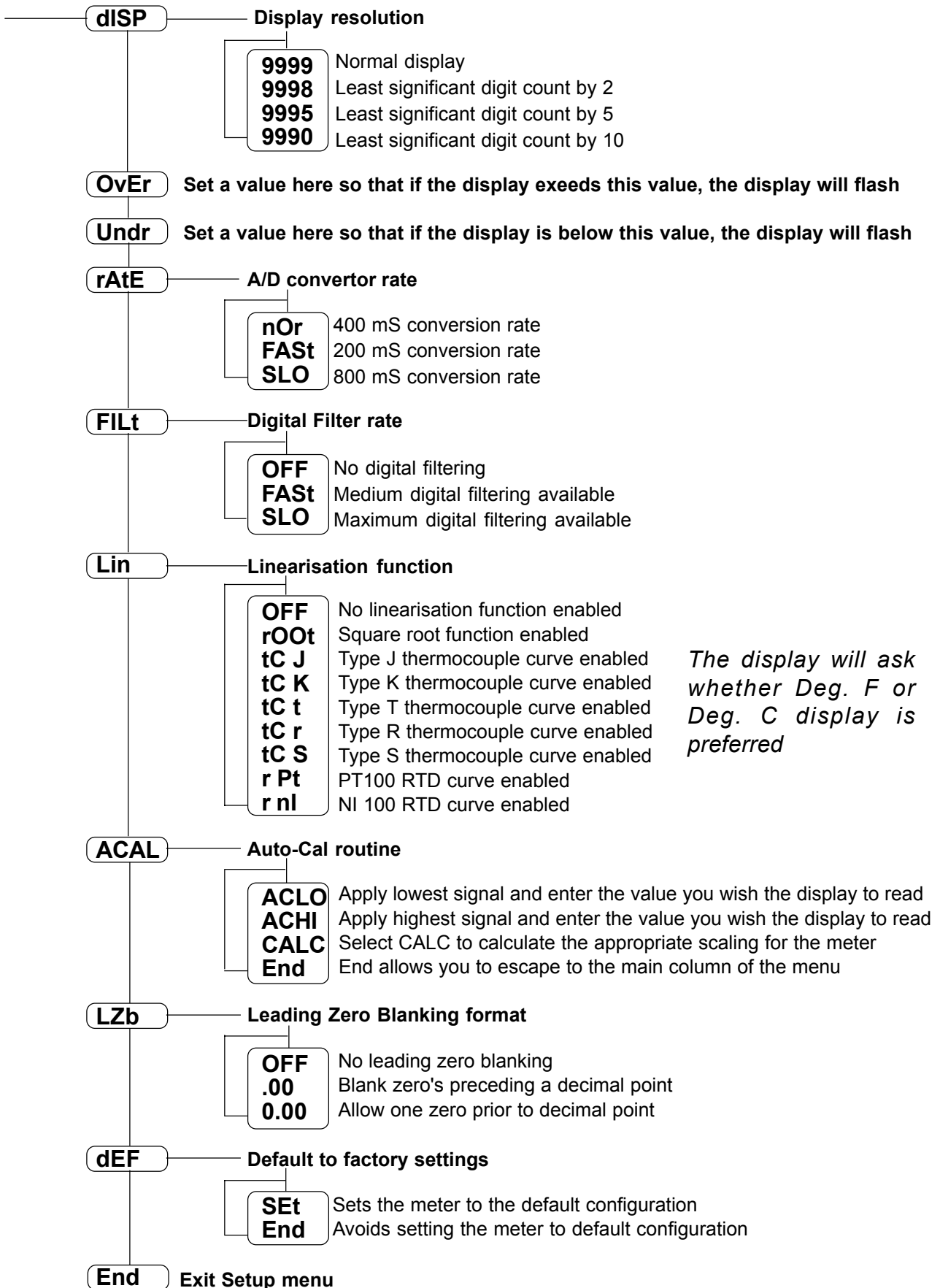



# ALARM 1 & 2 SETUP MENU

From Main Menu on p5...

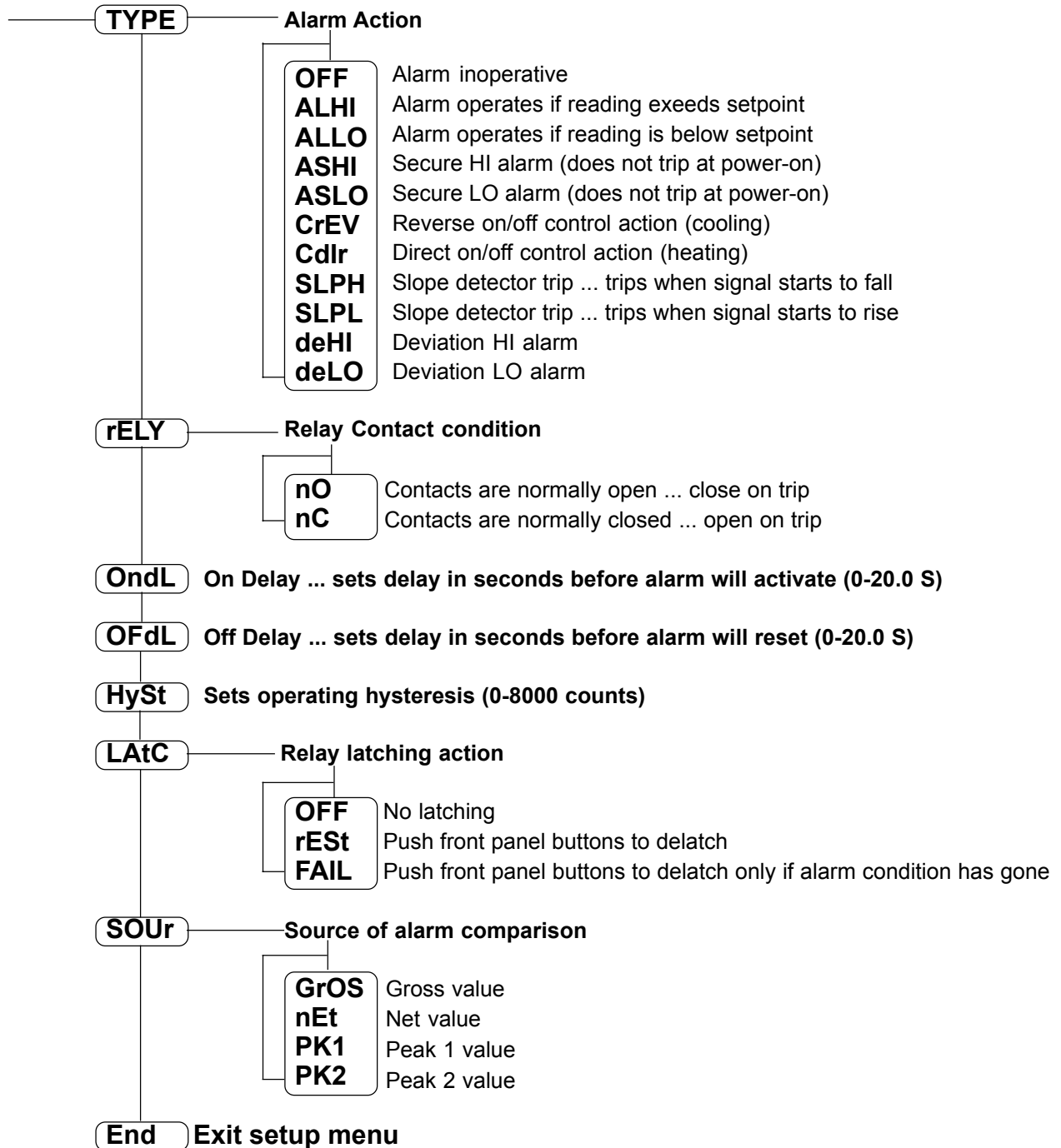

# ANALOGUE O/P MENU

From Main Menu on P5...

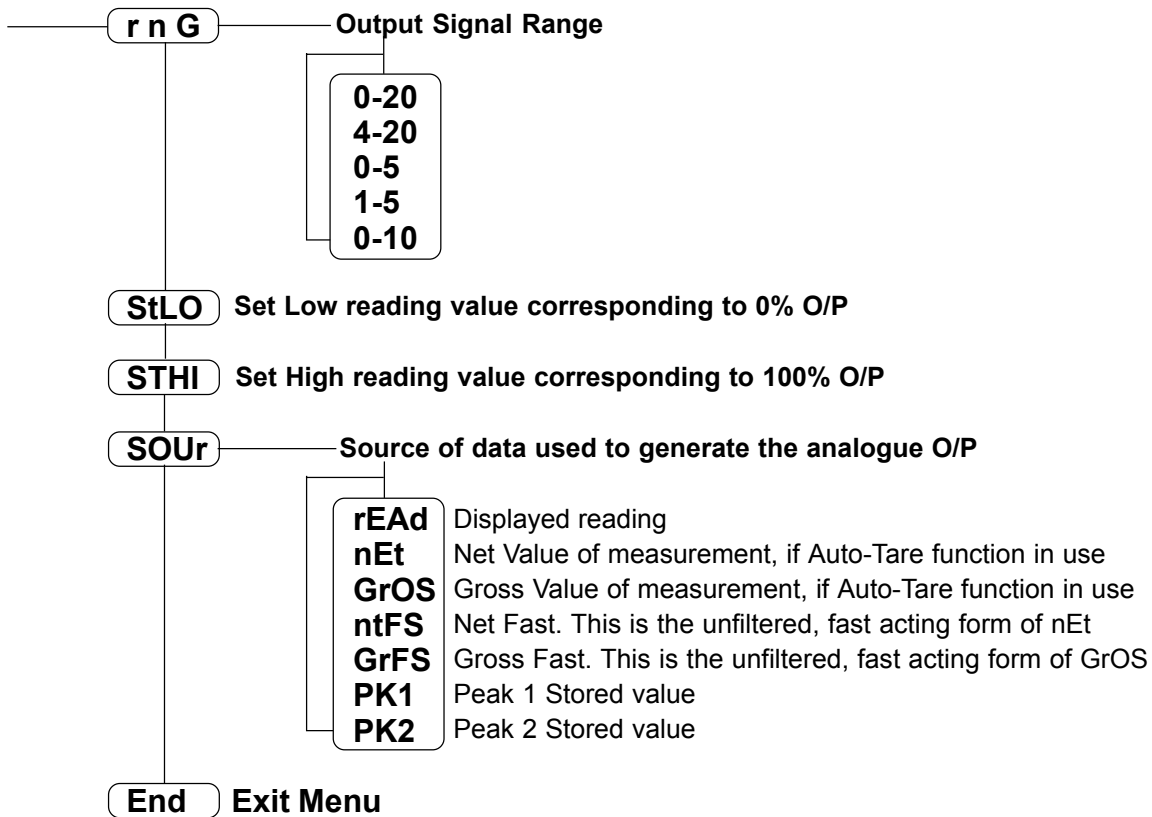

For example , if you have a measurement range of 0-5000 , and you require 4-20mA output to correspond to this range, set **rnG** to 4-20 , set **StLO** to 0, set **StHI** to 5000

# PRINTER PORT MENU

From Main Menu on P5...

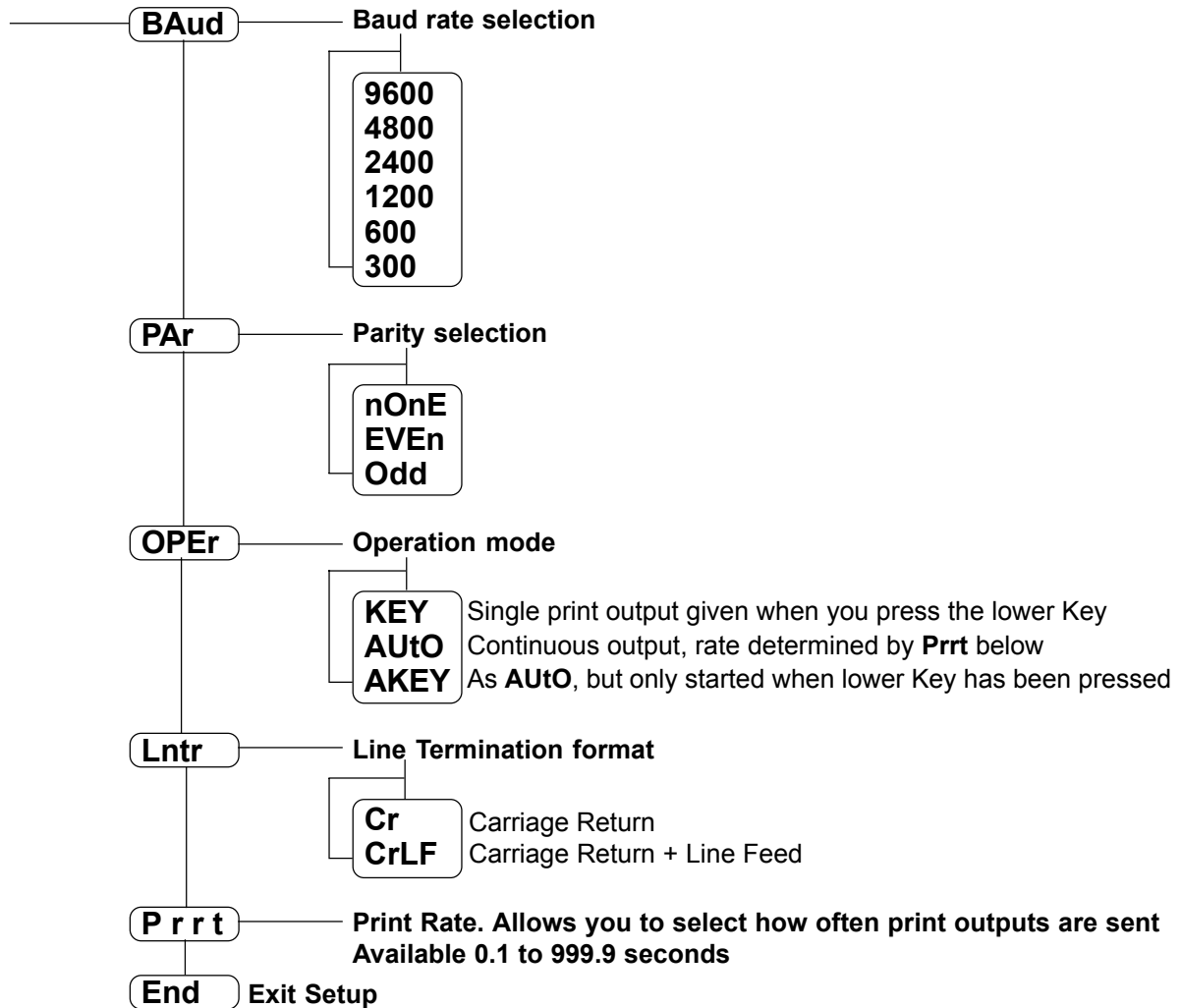

# PEAK, TARE & PASSWORD MENUS

## PEAK 1&2 MENU

From Main Menu on P5...

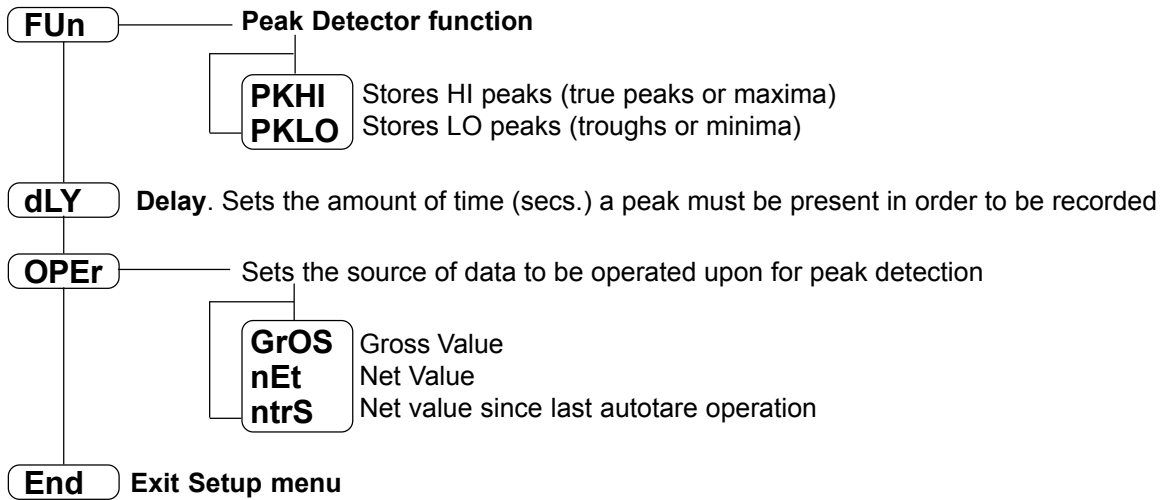

## TARE MENU

From Main Menu on P5...

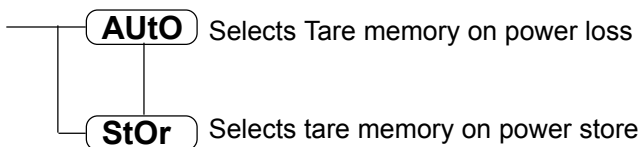

## PASSWORD MENU

From Main Menu on P5...

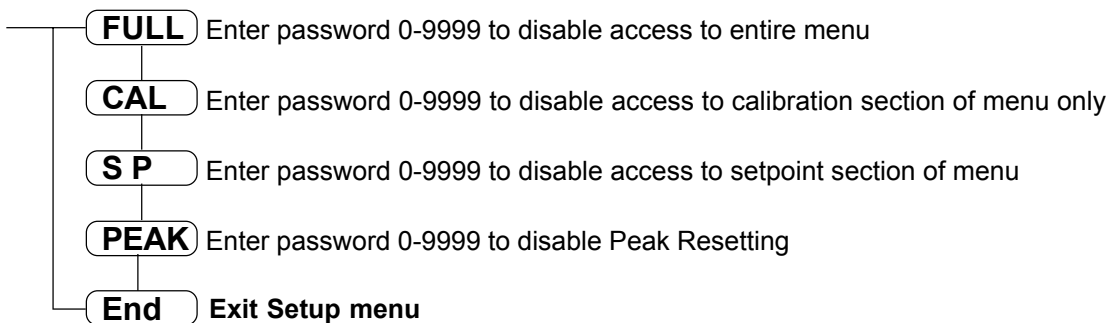

## ***SETTING ALARM LEVELS (if fitted)***

Press briefly to see AL1



Press briefly to see AL2

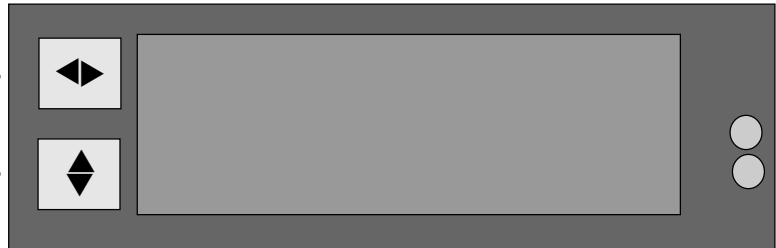

By momentarily pressing either of the pushbuttons, you may view the existing value of the setpoint trip point.

If you wish to alter the value of either trip point, press the appropriate button for more than 2 seconds. You will see the least-significant digit will brighten. You may alter its value by pressing the  key.

If you want to select other digits to alter, press the  key and alter with  key.

# Declaration of Conformity

Declaration Number : MICRO-LITE Iss. 1  
Issue Date : 2 Jan 1997  
Products Covered : MICRO-LITE - T,P & L  
Title : Miniature Smart Indicator

This is to confirm that the Products covered by this declaration have been designed and manufactured to meet the following specifications :

IEC 1010  
EN50081-1:1992 (normative)  
EN50082-1:1992 (normative)

and comply with the requirements of Council Directive 89/336/EEC relating to Electro-Magnetic Compatibility and 72/23/EEC relating to safety.

## Conditions

The meters are permitted a worst case error of 1% of A/D range during electro-magnetic disturbance, and must recover automatically when disturbance ceases without the need for human intervention, such as resetting, power-down etc.

The meters covered by this certificate must be installed in adherence to the following conditions :-

Signal cabling shall be routed separately to power carrying cabling (includes relay output wiring)  
All signal cabling shall be screened. The screen shall only be terminated to a clean power earth terminal as close to the meter as possible.

This certificate applies only to meters carrying Serial Numbers 701001 or higher.

Signed as true and correct, for and on behalf of London Electronics Ltd. ....

Warren Court, Chicksands, Shefford, Bedfordshire SG17 5QB

J.R. Lees  
Director