

London Electronics Limited

Thorncote Road, Near Sandy, Bedfordshire SG19 1PU
Tel +44(0)1767 626444 Fax +44(0)1767 626446
www.london-electronics.com help@london-electronics.com

Panel mounting resistance indicator / controller **INT2-R-COND**

Connection details, scaling and general information



Caution: There is a risk of electrical shock if this instrument is not properly installed



Caution: Risk of danger: Read the whole manual before you install this meter



A meter designed for monitoring extremely high resistance components, such as assumed open circuit switches, static dissipating materials etc.

It has an accurate measuring range of 5 Megohms to 1000 Megohms, and readings are presented in nanoSiemens (conductivity).

When combined with alarm relays, these meters are deal for use in QA applications where you need to provide an alarm if the resistance is above or below a certain level (conductivity below or above a certain level)

Resistance	Displayed conductivity.
10 000 Megohms	0.10
2 000 Megohms	0.50
1 000 Megohms	1.0
500 Megohms	2.00
200 Megohms	5.00
100 Megohms	10.00
50 Megohms	20.00
20 Megohms	50.00
10 Megohms	100.00
5 Megohms	200.00
<5 Megohms	-- or --

Software version F00.21

Document Ref:pm65\manuals\INT2_R Revision:20 Dated: 28 February 2011

Warranty

We warrant this product against defects in materials or workmanship for a period of three (3) years from the date of purchase.

In the event of a defect during the warranty period, the unit should be returned, freight (and all duties and taxes) prepaid by the Buyer to the authorised distributor from where the unit was purchased.

The Distributor, at its option, will repair or replace the defective unit. The unit will be returned to the Buyer with freight charges prepaid by the distributor.

LIMITATION OF WARRANTY

The foregoing warranty shall not apply to defects resulting from:

1. Improper or inadequate maintenance by the buyer.
2. Unauthorised modification or misuse.
3. Operation outside the environmental specification of the product.
4. Mishandling or abuse.

The warranty set forth above is exclusive and no other warranty, whether written or oral is expressed or implied. We specifically disclaim the implied warranties of merchantability and fitness for a particular purpose.

EXCLUSIVE REMEDIES

The remedies provided herein are the buyer's sole and exclusive remedies.

In no event shall we be liable for direct, indirect, incidental or consequential damages (including loss of profits) whether based on contract, tort or any other legal theory.

Contents

Warranty	2
Warnings	4
Introduction	5
General Description	6
Panel mounting & Installation - Class II	7
DIN Rail mounting option	8
Other Mounting options	9
Wiring Advice	10
Connections	11
Installation hints for best performance	12-13
Easy/Advanced menu mode	14
Language Selection	15
Display Brightness	16
Display Calibration Modes	17
Direct Calibration	18-19
Linearisation with Direct Calibration	20-21
Sensor Drift correction	22
Logic Input functions	23
Logic Input connections & Front Buttons	24
Factory defaults	25
Calibration Audit number	25
Signal Filtering / Averaging	26-27
Last Digit rounding	28
Scale Factor adjustment	29
Offset Adjustment	30
Menu Timeout adjustment	31
Reverse / Mirror display setting	32
Bootup Routine choices	33
Multi Memory MEM option	34
Error Codes	35
Output Options - installing	36
WEEE	37
Equipment Specifications	38
Record of Revisions	39
Declaration of Conformity	40

Separate manuals for options

Alarm option settings	See Alarm manual *
Analogue output option settings	See Analogue manual *
Serial output option settings	See Serial manual *
Real Time Clock setting	See Serial manual *

* Need a manual urgently?

You can download manuals from our website.

Warnings

Please carefully read this manual and all warnings. Install the meter ONLY when you are sure that you've covered all aspects.



Where the product is intended for "UL" installations, removal or addition of option boards is not permitted.



Check that the model number and supply voltage suit your application before you install the meter.



Connect the meter according to current IEE regulations, IEC61010 & NFPA:70 National Electric Code in USA.



This meter is for Installation class II service only. This means it has exposed electrical and power terminals. You must install it in a suitable fire enclosure which will also protect users from electric shock



We designed this meter for Pollution-Degree 2 environments only.



Power supplies to this equipment must have anti-surge (T) fuses rated at 400mA for 230V supply, 400mA for 110V supply or 2A for DC supplies in the range 11-30VDC. Only Siba fuses in series 189500, cULus listed according to file #E167295 are accepted for this service under the terms of UL listing. A switch or circuit breaker, clearly marked as a disconnecting device, must be included close to the installation.



Don't touch any circuitry after you have connected the meter, because there may be lethal voltages on the circuit board.



Only adjust on-board switches or connections with the power turned off



Make sure all screw terminals are tight before you switch the meter on.



Only clean the meter's front with a soft damp cloth. Only lightly dampen with water. Do not use any other solvents. The behind-panel case may be cleaned with a dry cloth only, use no liquid or solvent on it.

**Safety FirstDon't assume anything..... Always double check.
If in doubt, ask someone who is QUALIFIED to assist you in the subject.**

Introduction

Please contact us if you need help, if you have a complaint, or if you have suggestions to help us improve our products or services.

If you contact us about a product you already have, please tell us the full model number and serial number, so that we can give you accurate and fast help.

This product has a 3 year warranty. We will put right or replace any meter which is faulty because of bad workmanship or materials. This warranty does not cover damage caused by misuse or accident.

If you return a unit for repair, please include a detailed description of the problem, and the name of a contact who we can refer to for any questions. Please mark for the attention of the QA Department.

IMPORTANT

If this equipment is important to your process, you may want to buy a spare to cover possible failure or accidental damage in the future.

This is because during factory shutdown periods, you may have to wait several weeks for an equivalent replacement, or we may have no stock at the time you urgently need it.

You may also need to pay extra carriage charges if you want a fast, guaranteed courier service. Warranty repairs or replacements are usually returned with a standard courier service.

We do not offer compensation for losses caused by failure of this instrument.

If you do not agree with these conditions, please return this item in unused, condition, in its original packaging and we will refund the purchase price, excluding any carriage paid.

We thought you'd prefer to know about possible delays and extra charges now, rather than during a panic. A spare unit could help to avoid these issues.

We always try to improve our products and services, so these may change over time. You should keep this manual safely, because future manuals, for new designs, may not describe this product accurately.

We believe these instructions are accurate, and that we have competently designed and manufactured the product, but please let us know if you find any errors.

General Description

This series of meters accepts industrial sensors to allow various physical measurements to be made, such as weight, temperature, pressure, humidity etc. Different models are available for different sensor types.

The main function of this series is to give a numeric readout of the variable being monitored. Most models include an excitation power output, to power the sensor directly.

Various optional output modules are also available to give alarm relay outputs, analogue output or digital communications, or any combination of these options.

Meters are programmed using front panel pushbuttons. The buttons may be locked with a rear switch.

Meters have two power supply options : 100-240 VAC or 11-30VDC

These meters are designed to mount into a protective enclosure which will protect users from contact with power and signal wiring.

These units must be installed fully assembled, and must be installed according to local electrical installation rules. When properly installed, they provide ingress protection to IP65 / NEMA4X from the front

Safety



Caution: There is a risk of electrical shock if this instrument is not properly installed



Caution: Risk of danger: Read the whole manual before you install this meter

Obey all safety warnings in this manual, and install the meter according to local wiring and installation regulations. Failure to follow these guidelines may cause damage to the meter, connected equipment, or may be harmful to personnel.

Any moving mechanical device controlled by this equipment must have suitable access guards to prevent injury to personnel if the meter should fail.

Panel Mounting and Installation - Class II

Install the meters in a suitable protective electrical control enclosure according to local wiring regulations. See specifications for maximum allowable temperature in enclosure. Allow adequate air circulation.

Installing into front of panel
Remove the two rear bracket screws and safely store them and the U-Bracket for later fitting.

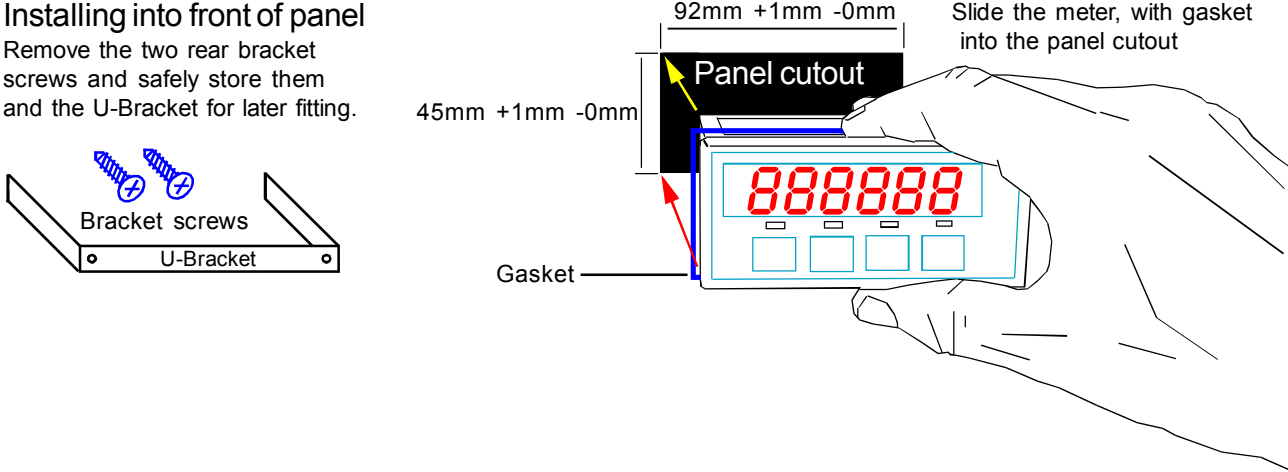

Slide the meter, with gasket into the panel cutout

92mm +1mm -0mm
45mm +1mm -0mm

Panel cutout

Gasket

Bracket screws
U-Bracket

Securing into the panel
Re-fit the U-Bracket and tighten the bracket screws to firmly clamp the meter in place. Check that the gasket is evenly pinched between the meter's front bezel and the enclosure front

Ventilation
There should be sufficient ventilation in the enclosure to ensure that the meter's case is always kept to less than 60C.

Meter Spacing.
Meters should be spaced apart sufficiently to allow a free flow of ventilation air around the meters, such that no part of the case will exceed 60C

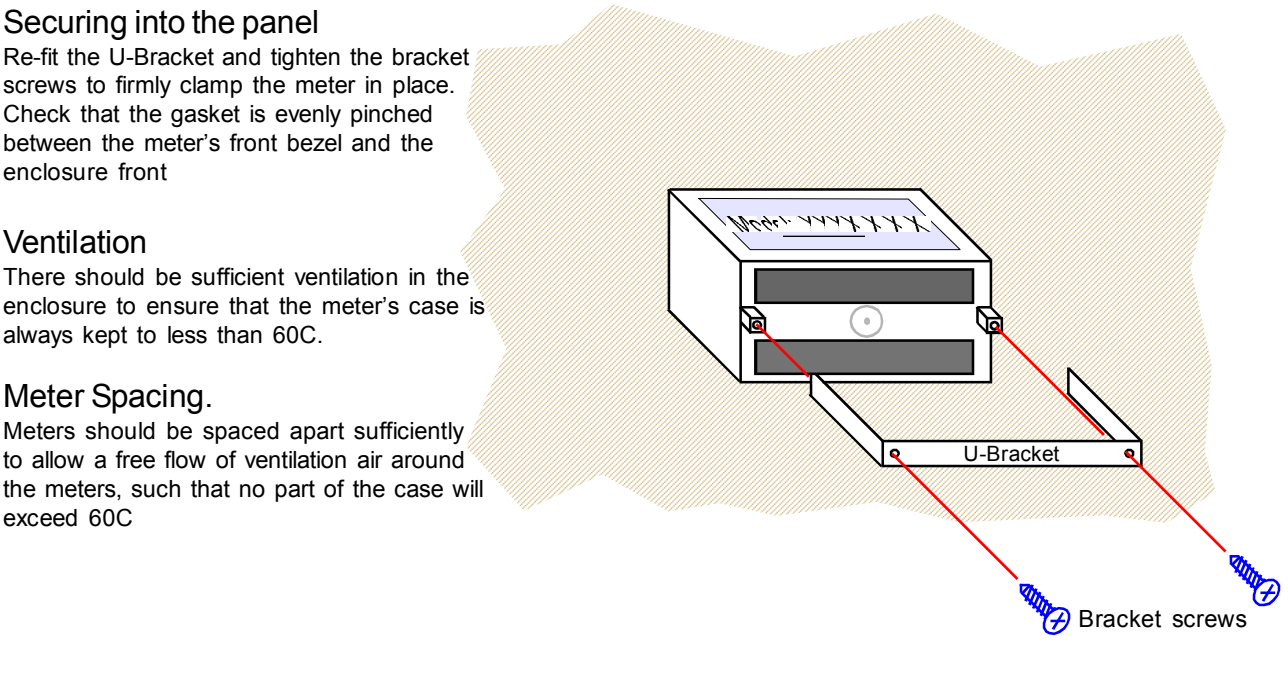

U-Bracket

Bracket screws

Side view of meter installed in panel

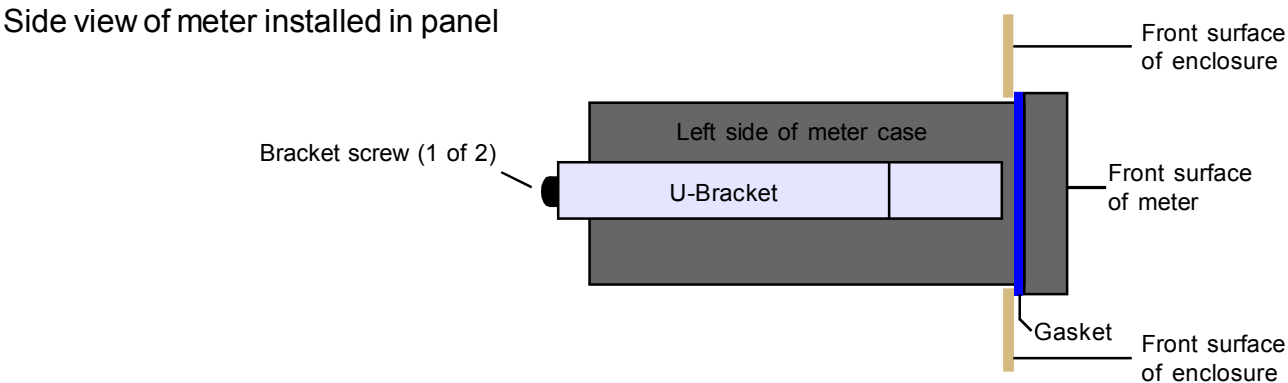

Bracket screw (1 of 2)

Left side of meter case

U-Bracket

Front surface of enclosure

Front surface of meter

Gasket

Front surface of enclosure

DIN Rail Mounting option

This Series is ideal if you need high precision signal conditioning. Sometimes, it is not necessary to have front panel indication, so in such cases, we offer a DIN rail mounting option, which allows the meter to be installed within a control panel.

Detachable connectors add to the simplicity of installation, and of course the setup method is identical to the panel mounting version, so you don't need to learn a new method.

The display remains active, so you can see at a glance the status of your signals, and programming is simple, using the 4 buttons.

Output functions include isolated 16 bit 4-20mA, 0-10V, -10 to +10V, RS232, RS485 and up to 4 alarms with a wide choice of alarm functions.

Install the meters in a suitable protective electrical control enclosure according to local wiring regulations. See specifications for maximum allowable temperature in enclosure. Allow adequate air circulation.

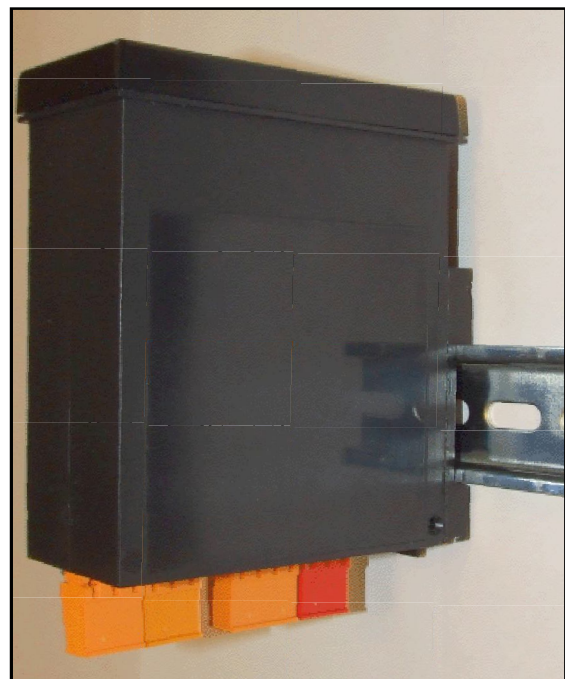

Securing into the panel

Use standard top-Hat DIN rail 35 mm x 7.5 mm (EN 50022, BS 5584, DIN 46277-3)

Ventilation

There should be sufficient ventilation in the enclosure to ensure that the meter's case is always kept to less than 60C.

Meter Spacing.

Meters should be spaced apart sufficiently to allow a free flow of ventilation air around the meters, such that no part of the case will exceed 60C

Other mounting options

IP67 SPC4

The SPC4 splashproof cover gives IP67 / NEMA4-X protection for the front of your meter. Ideal for use in harsh wet environments.

Available with optional security tag ports to allow you to fit your own crimped wire tamper-seals, to prevent or indicate unauthorised access (Similar to tags used on electricity meters)

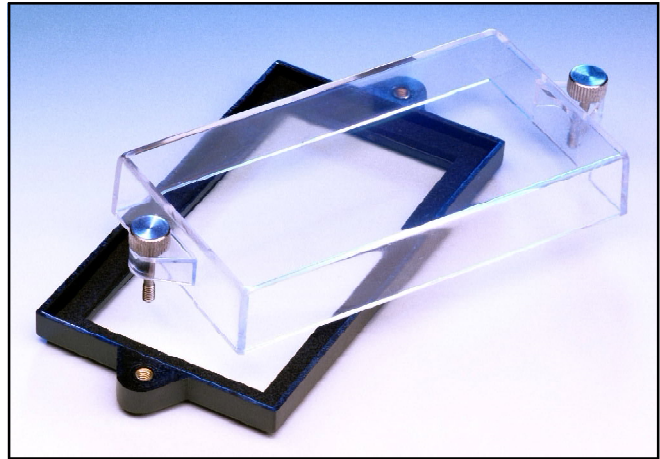

Wall Box

The Wallbox is sealed IP65 all round, and is supplied with the meter installed, for you to wire to, via 3 cable glands. It comes complete with SPC4 splashproof cover.

We also offer a dual version of this enclosure, which can take 2 meters, one above the other.



PCC Series

The PCC series of Portable Carrying cases is ideal for housing your panel meters so that they can be used in the lab. These enclosure come fully wired, with panel meters fitted and with IEC switched power connector plus any input or output connectors, as required.

Versions are available to accept 1, 2, 4, 6, 8, 12 or 16 meters



Wiring Advice

This meter uses detachable screw terminal connectors. Refer to the wiring diagram on the following page for the correct positioning of each wire.

The conductors you use must be suitable for the meter's temperature, current and voltage rating, which is broadly described as follows:-

Cable Temperature Rating

All cables must be rated for operation up to 90C continuous.

Cable gauge and screw tightness

The connectors on this instrument can accept conductors up to 16 gauge AWG / 1.5mm² c.s.a. The minimum cross sectional area shall be 22 gauge AWG / 0.5mm². Tighten screw terminals to 7.0 lb/in torque / 0.8 Nm torque.

Cable insulation voltage rating

Cables shall have an insulation voltage rating of at least 380V continuous.

Wire preparation:

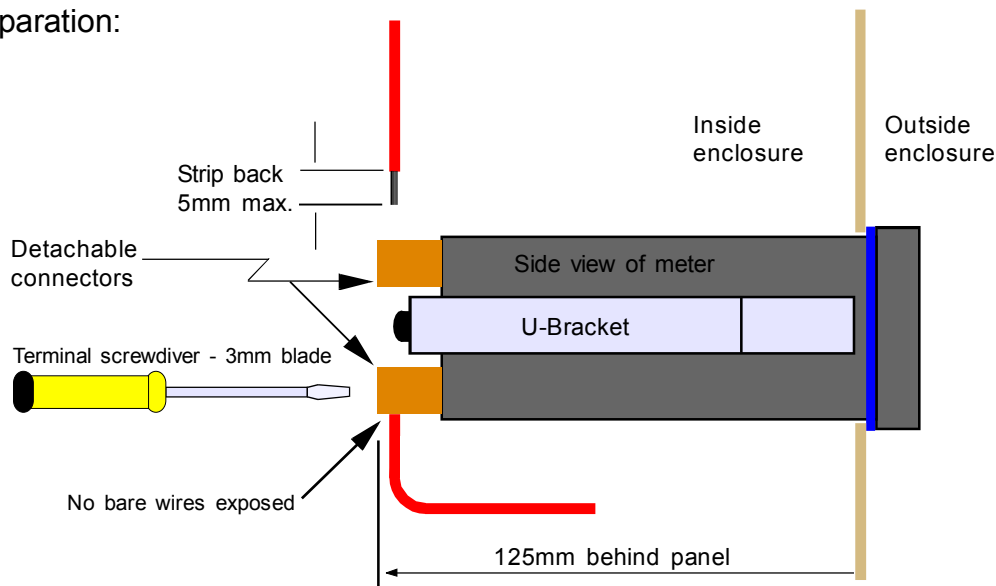

We recommend multi-strand wire, because it withstands vibration better than single strand cable. Pull the wire firmly after you make the connection to confirm it is tight.

Use screened cable for all signal and control wiring and connect the screen to earth at the destination end only. Route signal cabling away from power cabling and relay switching cabling, to avoid electrical noise interference.

Connections

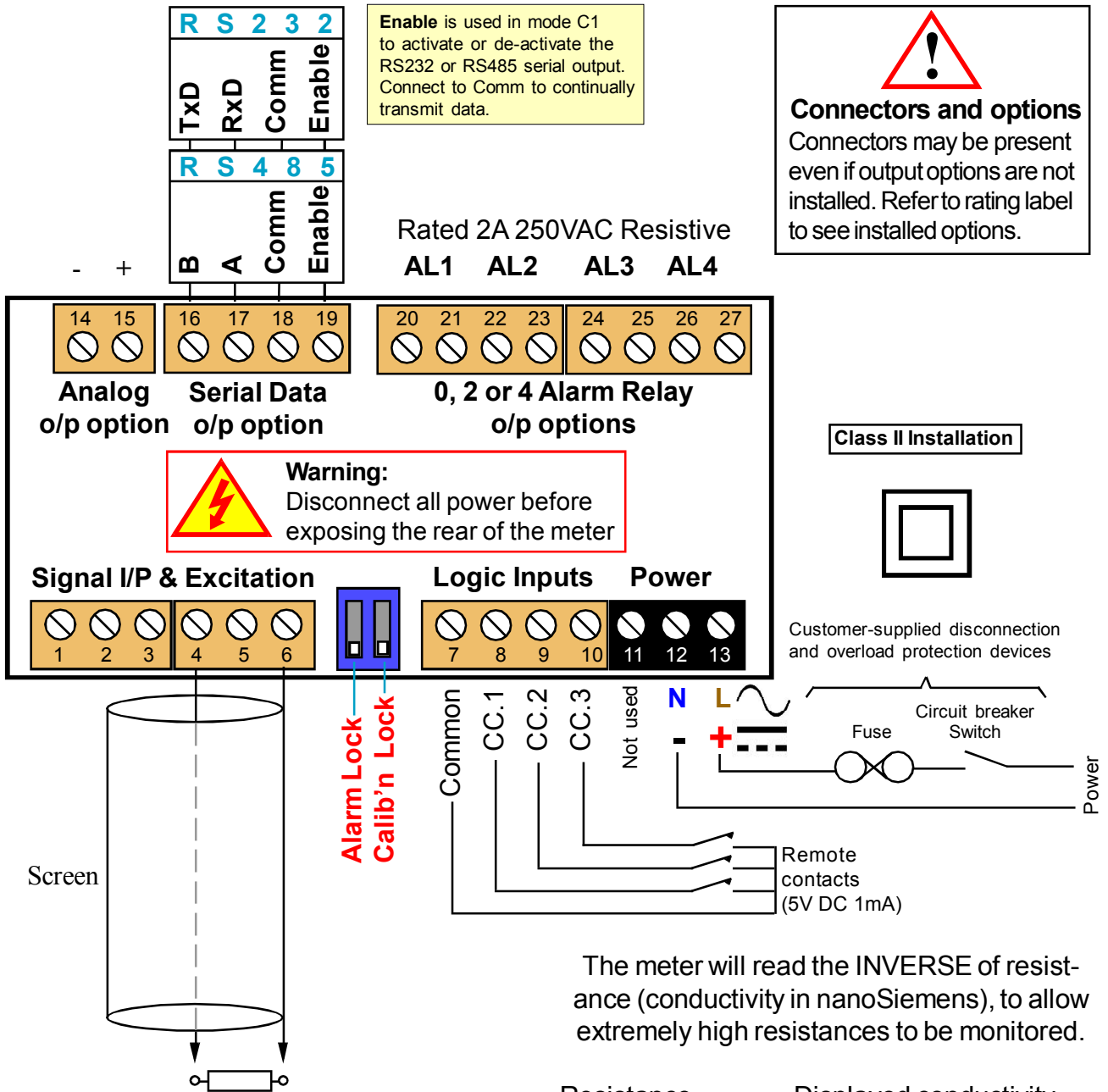

The meter will read the INVERSE of resistance (conductivity in nanoSiemens), to allow extremely high resistances to be monitored.

Resistance	Displayed conductivity.
10000 Megohms	0.10
2000 Megohms	0.50
1000 Megohms	1.0
500 Megohms	2.00
200 Megohms	5.00
100 Megohms	10.00
50 Megohms	20.00
20 Megohms	50.00
10 Megohms	100.00
5 Megohms	200.00
<5 Megohms	-- or --

It is important to ensure that the wire from terminal 4 is screened. The screen connects to terminal 6. Keep this cable away from all sources of electrical noise and keep it as short as possible.

Installation hints for best performance

This section offers several suggestions which will help you get the best performance from your weighing system.

Loadcells create very small signals which can easily be corrupted by electrical noise. These steps will ensure you get the best possible performance from your meter.

1. Use good quality screened signal cable, with 3 twisted pairs. Belden 8777NH, Belden 9503 and AlphaWire 6010C are good choices, available from many electrical distributors.
2. Even if your loadcell is only a 4 wire device, we recommend you use 6 core cable between the display and the loadcell, and wire as shown in the diagram opposite. This will ensure that any resistance changes in your cabling, caused by changes in temperature, will be cancelled.
3. Each pair should be dedicated to a signal function as shown opposite, for maximum noise immunity. (One twisted pair for Excitation, one twisted pair for Sense, one twisted pair for Signal) This will ensure that any electrical noise induced in the cable is properly cancelled. Mixing functions carelessly amongst the twisted pairs can actually worsen noise performance.
4. The cable should be routed away from noisy wiring and devices such as power feeds from inverters, discharge-lighting cables, welder cabling etc, and should preferably be routed in a dedicated low voltage signalling/instrumentation conduit or cable tray.
5. Screened cable should be earthed at the display end only.
6. All wires and screens coming out of the screened cable should be kept as short as possible to minimise pickup of noise.
7. If you are using barriers, you should earth your screen as shown below, paying particular care that you do not earth both ends of any run of of cable. **NB** If using galvanic isolation barriers, connect 10K from terminal 2 to terminal 3 and 10K from terminal 3 to terminal 5 on the display's Sig. Input connector to maintain the input signal within the common mode range of the excitation sense circuit.

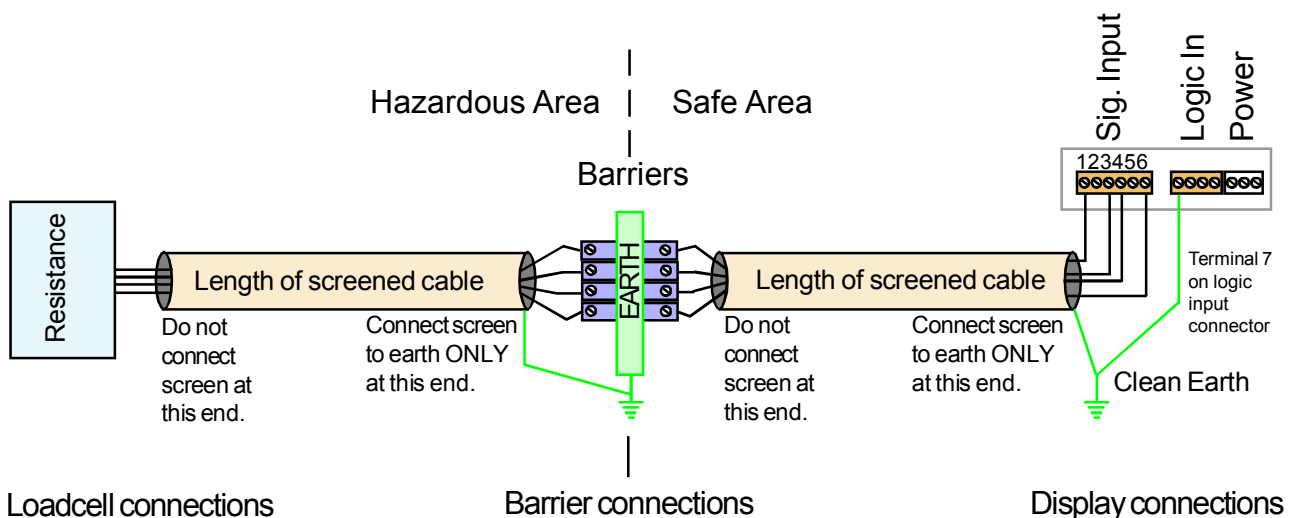

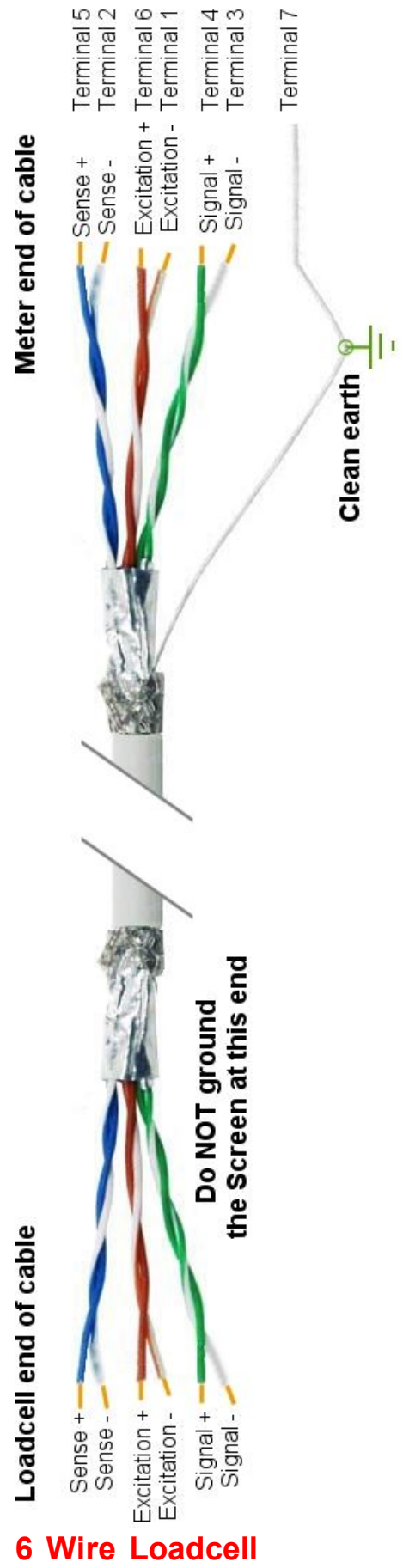
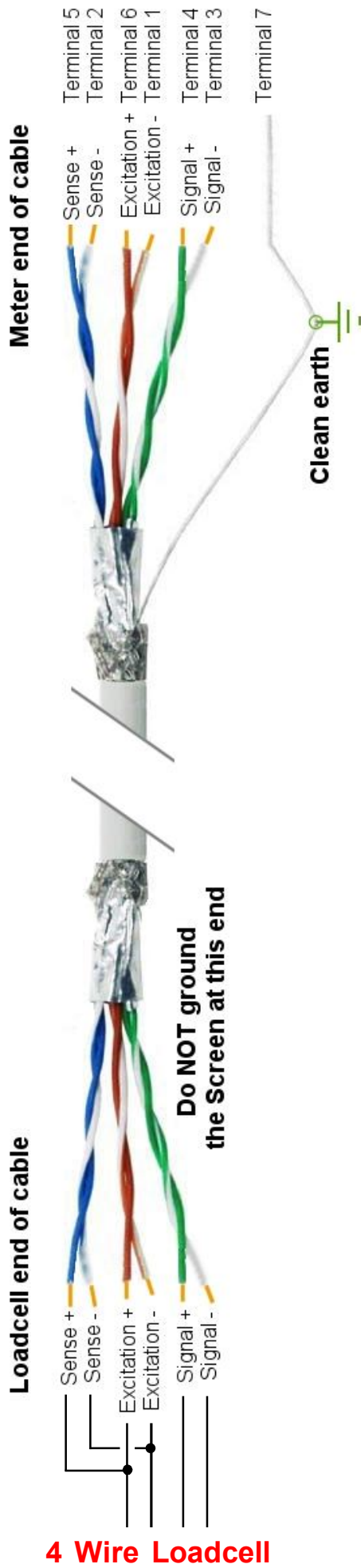

Easy or Advanced menu mode

You can choose from two menu modes.

1. Easy Mode - This limits the menu to the most commonly required features, in order to make it less complex and easier to navigate. This is the default level.

2. Advanced Mode - This gives you access to all available menu features.



Each menu feature in this manual has a heading note to tell you whether it is available in Easy or Advanced mode.

How to choose menu mode:-

This feature is available in Easy and Advanced Modes

- Lockout Switch must be OFF

Circuit board ON

Press together briefly
- Press OK a few times, until you see **Adv.** or **EASY**

Press briefly
- Each press of the DOWN arrow, or UP arrow will alternate between showing **Adv.** or **EASY**

Press to toggle
- Press OK to select your choice.

Done!

Press to accept

Language Selection for user interface

You can select English or French menu prompts.

This feature is available in Easy and Advanced Modes

1

Set1 Digit Set2 Max/Min Output Alarms Lockout Switch must be OFF OFF

Press together, briefly

Circuit board ON

2

Set1 Digit Set2 Max/Min Output Alarms OK

Press to toggle

Display shows

U I E n B (Default)
for User Interface English
or
U I F r A
for User Interface French

3

Set1 Digit Set2 Max/Min Output Reset Alarms OK

Press to accept

Done!

Display Brightness

You can adjust the display brightness at any time, provided the display is locked.

This feature is available in Easy and Advanced Modes

- 1**

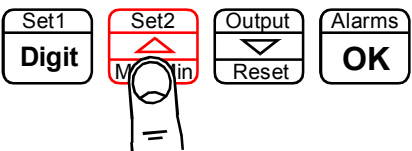

Press 3 seconds

Lockout Switch must be ON

Circuit board ON
- 2**

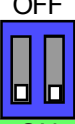

Press for 3 seconds

Display shows **br ight**

Each press of the UP button will select a new brightness level. There are 7 brightness levels to choose from. (Default = Full brightness)
- 3**

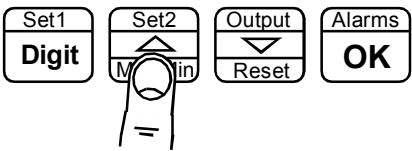

Press to accept

Done!



Did you know, we make this display in two brightness versions? Standard brightness for use inside, and Daylight Viewing for use outside in direct sunlight. The Daylight Viewing version has suffix -DLV in its part number.

Meter Calibration Modes

You can choose from two main calibration methods.

1. Direct Calibration - this is when you connect the meter to your system and make the meter read what you want it to, at 2 different points, using a reference resistor. *This is the preferred calibration method, because it allows you to calibrate the system as a whole.*

2. Theoretical Calibration - this is not a recommended mode for this model.

How to choose a calibration method:-

This feature is available in Easy and Advanced Modes

- 1**

Set1 Digit Set2 Max/Min Output Reset Alarms OK

Press 3 seconds

Lockout Switch must be OFF

Circuit board ON
- 2**

Set1 Digit Set2 Max/Min Output Reset Alarms OK

Press to select dirECt or thEor

Display shows CAL Src then
dirECt
or
thEor (do not select)
- 3**

Set1 Digit Set2 Max/Min Output Reset Alarms OK

Press to accept

Done!

Direct Calibration - Full Scale Setting

This is when you connect the meter to your system and make the meter read what you want it to, at 2 different points. *This is the preferred calibration method, because it allows you to calibrate the system as a whole.*

How to do direct calibration:-

If you have not done so before, please select Direct Calibration mode from the previous page.

First we recommend you set the **FULL SCALE** calibration ...

This feature is available in Easy and Advanced Modes

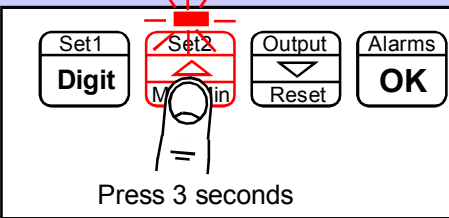
- 

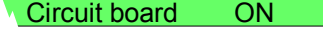
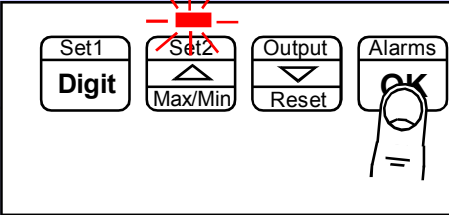
Lockout Switch must be OFF 
Display shows **d rECT** followed by **SEt H ,** 
- 

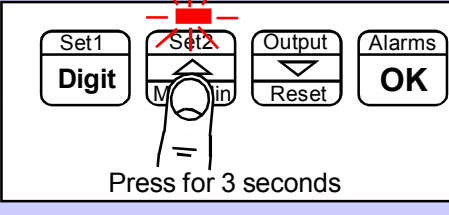
Apply the highest calibration resistance. We recommend 200 Megohms, which is 5.00 nanoSiemens
Press OK.
- 

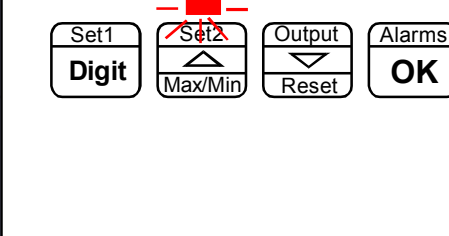
Press Set2 for 3 seconds. You can now set your decimal point position using the UP or DOWN buttons.
Press OK when done.
- 

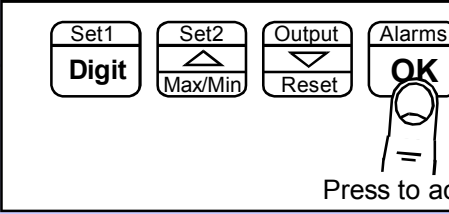
You can now set the display value to 5.00 nS - use DIGIT to select each digit in turn, and the UP or DOWN arrow to increase or decrease each digit's value, as required.
- 

Press to accept  **Done!**

Direct Calibration - Zero Setting

How to calibrate the **ZERO** point.

This feature is available in Easy and Advanced Modes

- 1**

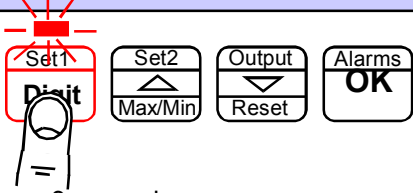

Press 3 seconds

Lockout Switch must be OFF

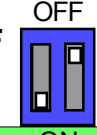

Circuit board ON
- 2**

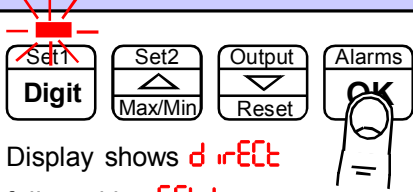

Display shows **d rECT** followed by **Set Lo**

Ensure that the resistance probes are left in free air, as we want infinite resistance to be presented to the meter at this time (Zero nanoSiemens). Press OK.
- 3**

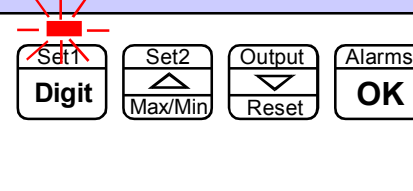

You can now set the display value to 0.00 nS - use DIGIT to select each digit in turn, and the UP or DOWN arrow to increase or decrease each digit's value, as required.
- 4**

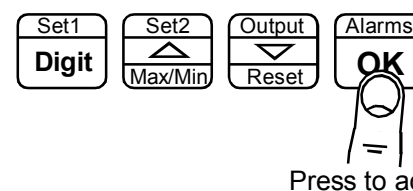

Press to accept



Done!

When you have finished your calibration, please remember to put the calibration lockout switch in its ON position, to protect your settings.

Linearisation with Direct Calibration

If your system is non linear, you can calibrate the meter to have a non linear response to resistance.

You will need to apply a series of known resistances, starting at 0 and working up to full scale. You will then tell the meter what it should read for each applied resistance. You can use up to 10 points.

First, you must select Direct Calibration Mode (see page on calibration Modes)
Then, proceed as shown below...

This feature is available in Easy and Advanced Modes

- 1

Set1
Digit

Set2
Max/Min

Output
Reset

Alarms
OK

Lockout Switch must be OFF

Display will show L in.0n or L in.OFF (Default)

OFF

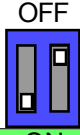

Circuit board ON

Press together, briefly
- 2

Set1
Digit

Set2
Max/Min

Output
Reset

Alarms
OK

If the display shows L in.OFF, press Set2 button briefly so that the display shows L in.0n, then press OK
- 3

Set1
Digit

Set2
Max/Min

Output
Reset

Alarms
OK

The display will show SEt 00

Ensure 0 Ohms is applied to the system and press OK.

The display will now show rd 00

You can now tell the meter what it should display for this resistance.

Select each digit in turn with the DIGIT button, and increase or decrease each digit's value using the UP or DOWN button, until the display is set as required. Press OK when done.
- 4

Set1
Digit

Set2
Max/Min

Output
Reset

Alarms
OK

The display will show Add.Pt

Press OK

Continued ...

Linearisation with Direct Calibration - cont'd.

5

Set1
Digit

Set2
Max/Min

Output
Reset

Alarms
OK

The display will show **Set 0!**
Apply your 1st known resistance to the system and press OK.

The display will now show **rd 0!**
You can now tell the meter what it should display for this resistance.

Select each digit in turn with the DIGIT button, and increase or decrease each digit's value using the UP or DOWN button, until the display is set as required. Press OK when done.

6

Set1
Digit

Set2
Max/Min

Output
Reset

Alarms
OK

The display will show **Add Pt**

Press OK if you want to Add another calibration point, you will repeat the previous steps, each time incrementing "Set XX" and "rd XX" up to Set 09 and rd 09 which are the last available points.

If you want to finish adding points, press Set2 until the display shows **SAVE**, and then confirm by pressing OK

If you want to abort the setup, press Set2 until the display shows **Quit** and then press OK

7

Set1
Digit

Set2
Max/Min

Output
Reset

Alarms
OK

Done!

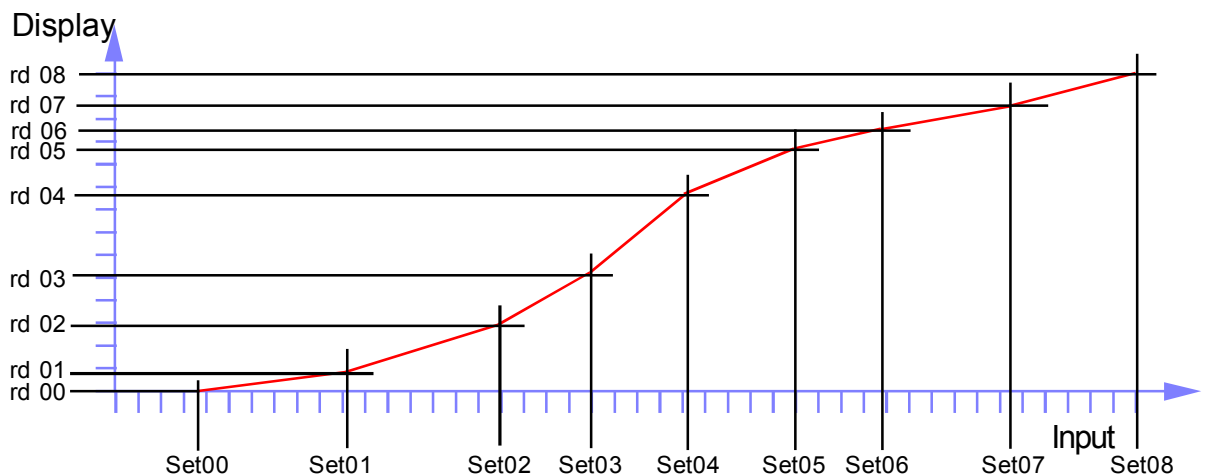

Sensor Drift correction

If your system is normally reading 0 nS, you may find a small amount of sensor drift caused by changes in temperature, ageing etc.

We can automatically correct for slow, long term drift, by comparing your signal to 0 every 30 seconds, and re-calibrating to remove any detected movement.

This does not affect the sensitivity of your system, and is only applied for readings less than 8 least-significant counts.

The corrected value is stored in non-volatile memory, so that any drift trend will be re-applied after you have switched off the meter.

This feature is available in Easy and Advanced Modes

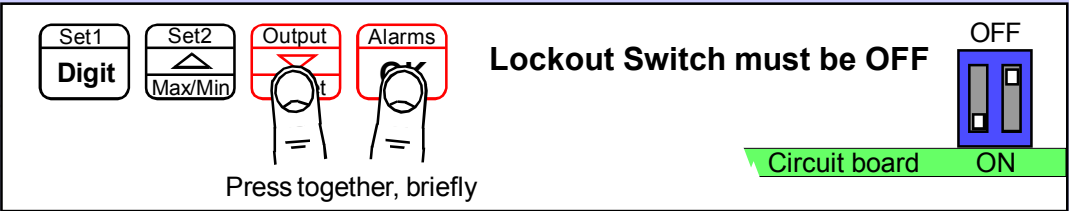
- 

1 — Press together, briefly

Lockout Switch must be OFF

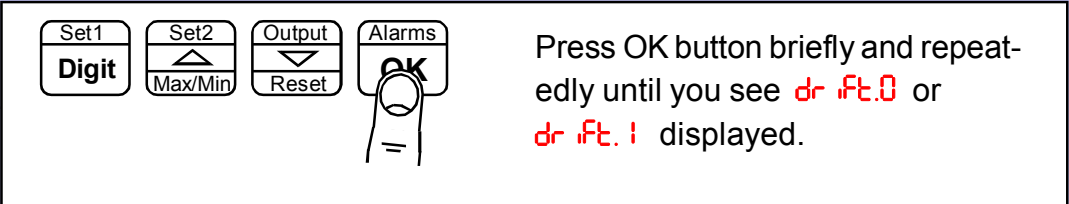
Circuit board ON
- 

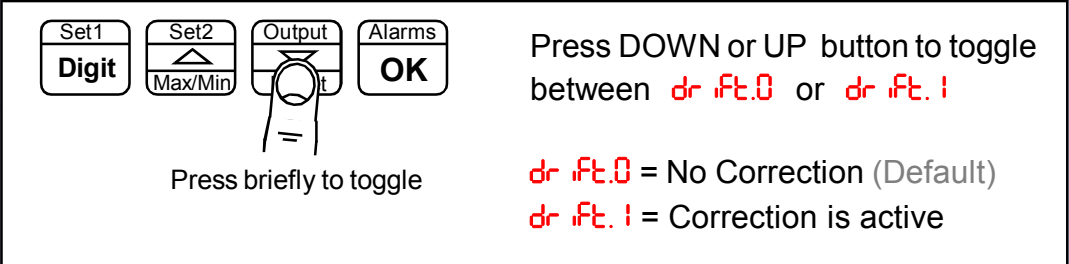
2 — Press OK button briefly and repeatedly until you see **drift.0** or **drift.1** displayed.
- 

3 — Press DOWN or UP button to toggle between **drift.0** or **drift.1**

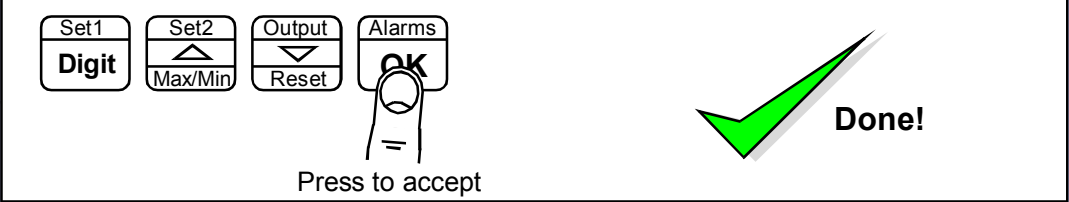
drift.0 = No Correction (Default)
drift.1 = Correction is active
- 

4 — Press to accept

Done!

Logic input functions

The three contact closure inputs on the rear of the meter have default functions which are:-

- Contact closure 1 = Tare
- Contact closure 2 = Peak/Valley display
- Contact closure 3 = Reset

You can re-assign these to include :HOLD, Nett/Gross value display, Memory page address 1,2 or 4 (only if Multi-memory MEM option is installed)

!! This feature is available in Advanced Mode only !!

1

Set1
Digit
Set2
Max/Min
Output
Reset
Alarms
OK

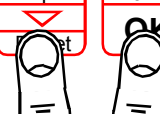

Press 3 seconds

Lockout Switch must be OFF

OFF

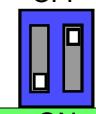

Circuit board

ON

2

Set1
Digit
Set2
Max/Min
Output
Reset
Alarms
OK

Press repeatedly until you see **CC.1**, followed by the existing function for Contact Closure 1.

After you have set **CC.1**, you will get the prompt **CC.2** to allow you to set Contact Closure 2 function and when you have set CC.2 you will get the prompt **CC.3** to allow you to set Contact Closure 3 function

3

Set1
Digit
Set2
Max/Min
Output
Reset
Alarms
OK

Use UP or DOWN buttons to select from these available functions...

<p>Defaults are:-</p> <p>CC.1 = TARE</p> <p>CC.2 = PU</p> <p>CC.3 = rSt</p>	<p>TARE = Tare display to 0</p> <p>PU = Peak/Valley toggle</p> <p>rSt = Reset</p> <p>HoLd = Freeze display</p> <p>neTt.Gro = Nett / Gross display</p> <p>PA.1 = Page Address 1*</p> <p>PA.2 = Page Address 2*</p> <p>PA.4 = Page Address 4*</p>
--	---

4

Set1
Digit
Set2
Max/Min
Output
Reset
Alarms
OK



Press to accept



Done!

* Only available if the Multi-memory MEM option is installed

Logic input connections and front buttons

The previous page explained how to select the functions of the 3 logic inputs. You can connect remote contact closures or open NPN collectors to activate these logic inputs.

The logic input provides a 5V DC signal. When you connect this to common, a current of 1mA will flow. Because this is a small signal, we recommend you use switches with gold plated contacts, or self cleaning contacts, for best long term reliability.

The logic inputs are not galvanically isolated from the input signal.

The logic inputs are only activated when the lockout switch is ON

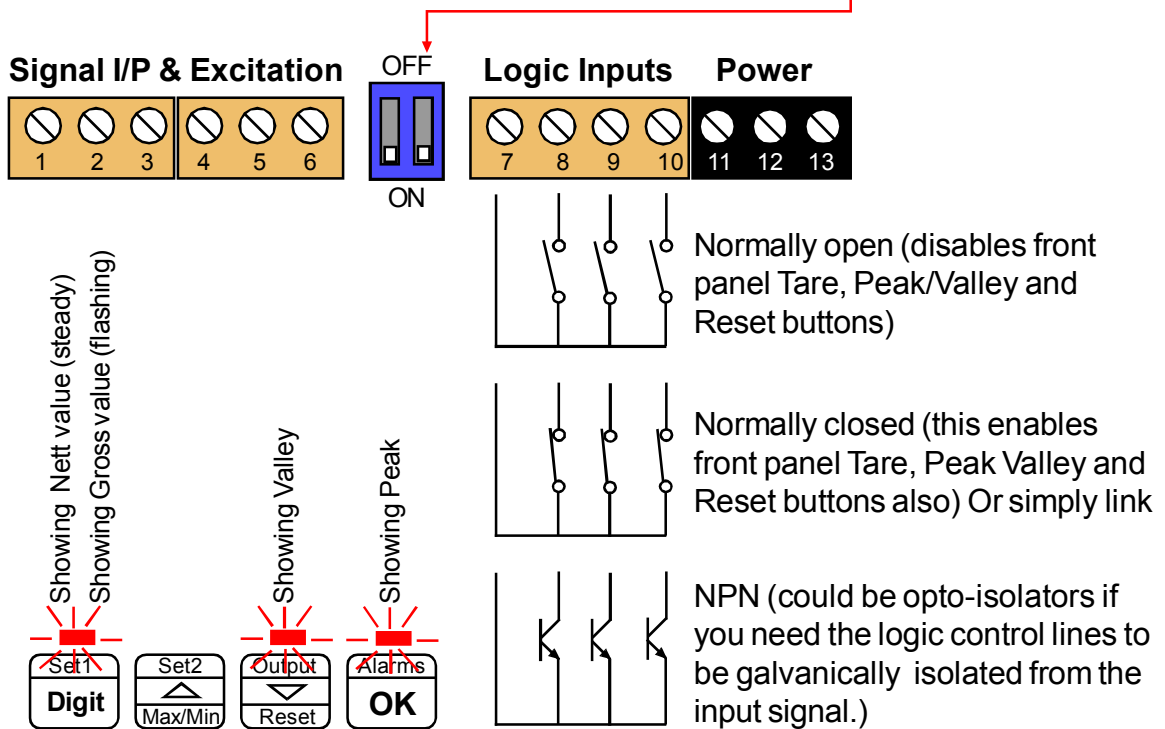

TARE = Tares display to 0. Often used in weighing systems to zero a display prior to making a measurement. Net weight is shown once tared. When a display has been tared the small LED above the Set1 button will be illuminated.

PU = Peak/Valley toggle. Allows you to view the maximum and minimum values which have been displayed since last reset. 0% LED illuminates when showing valley, 100% LED illuminates when showing peak.

rst = Reset. This clears any tare, peak, valley, alarm latch

Hold = Freezes the displayed value for as long as the Hold input is closed

net.gro = Allows you to toggle between Nett and Gross values on the display

PA.1 .. 4 = Page Addresses, if MEM option is installed.

Factory Defaults

You can return the display to its factory default conditions whenever you wish. If you do so, you will permanently lose all your settings and will need to start from the beginning again.

The calibration Audit Counter will NOT be reset, there is no way provided to reset this value, as it is intended as a secure record to indicate whether changes have been made to the display since it was last calibrated..

This feature is available in Easy and Advanced Modes

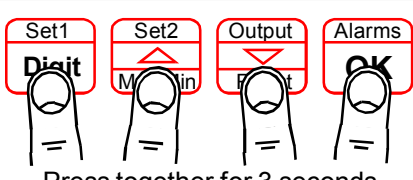
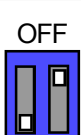
1 —  **Lockout Switch must be OFF** 
Press together for 3 seconds

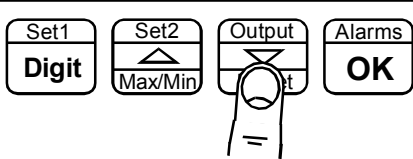
2 —  **Display shows :-**
dEFS n (Defaults no)
Press the DOWN button to change the display to **dEFS Y** (Defaults Yes) if you want to return to default conditions.

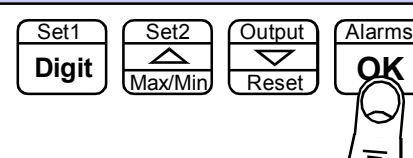
3 —  **Done!**
Press to accept

Calibration audit number

Your display includes a non-resettable counter which increments each time you make a change to the display's calibration. This is useful if you want to check whether a display has been altered since it was last calibrated.

The Calibration audit number starts at **CAL 01** up to **CAL FF** allowing up to 255 alterations to be recorded. Whenever you want to check the calibration audit number, press and hold the 2 outer buttons (Set1 + Alarms) for more than 3 seconds.

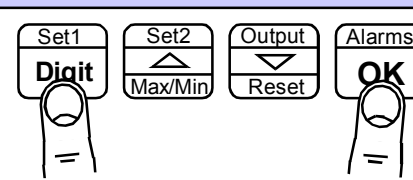
1 —  **Done!**
Press together for 3 seconds

Signal Filtering / Averaging

You can adjust the filtering time constant to reduce the effect of noise or instability on your input signal.

A larger FIL value will give a more stable display, but the response to signal changes will be slower.

Because your output options, such as analogue output, alarm relays and serial output are all derived from the displayed value, they will respond at the same rate as the filtered display.

This feature is available in Easy and Advanced Modes

- 1** Lockout Switch must be OFF
Press 3 seconds
Circuit board ON
- 2** Display shows **F IL.XX.X** where **XX.X** is the time constant in seconds. Use the UP or DOWN button to increase or decrease this value (Default = **F IL.00.0**)
- 3** Done!
Press to accept

See also Filter Jump setting in the Advanced Menu, if your signal is particularly noisy and you cannot get sufficient smoothing with this filter.

Filter Jump value

See the Easy/Advanced mode selection page near the beginning of this manual, and choose advanced mode.

The Filter Jump value allows you to decide how the display will respond to a process step change. It does this by overriding the filtering, if the input signal moves by more than a chosen amount in one conversion. The Filter Jump default value is 10%.

This means that for noise amplitude which has a peak value of less than 10% of the input range, filtering will be applied. Any signal movement greater than 10% of the input range will cause the display to jump immediately to that value, without filtering. After that jump, normal filtering will be re-applied, provided signal movement thereafter is less than 10% per conversion.

Guidance:

For noisy systems, increase the Filter Jump value up to a maximum of 99. Choose a value which gives a good compromise between filtering and response speed.

For reasonably clean signals, a Filter Jump value of around 10 or less will give a good compromise between filtering and response speed to step change inputs.

!! This feature is available in Advanced Mode only !!

1

Set1	Set2	Output	Alarms
Digit	▲ Min	▼ Set	OK

Press 3 seconds

Press 3 seconds

Set1	Set2	Output	Alarms
Digit	▲ Max/Min	▼ Reset	OK

Lockout Switch must be OFF

OFF
ON

Circuit board

2

Set1	Set2	Output	Alarms
Digit	▲ Max/Min	▼ Reset	OK

Press repeatedly until you see **F L.J.XX** where **XX** is the Filter Jump percentage (Default = **F L.J.09**)

3

Set1	Set2	Output	Alarms
Digit	▲ Max/Min	▼ Reset	OK

Set1	Set2	Output	Alarms
Digit	▲ Max/Min	▼ Reset	OK

You can set from **00** to **99**. Use the DIGIT and UP or DOWN button to increase or decrease this value.

4

Set1	Set2	Output	Alarms
Digit	▲ Max/Min	▼ Reset	OK

Done!



Press repeatedly to accept and return to display

Last Digit rounding up by 1, 2, 5, 10, 20 or 50

You can adjust the way the display rounds up, which is useful if you want to display a very large number, but do not want jitter on the last digit.

The display can be set to round up to the nearest 1 (no rounding) 2, 5, 10, 20 or 50

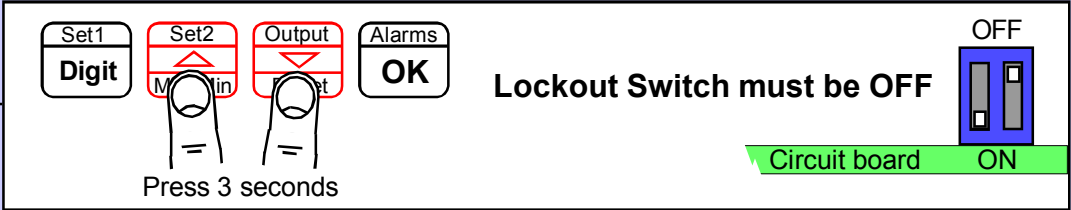
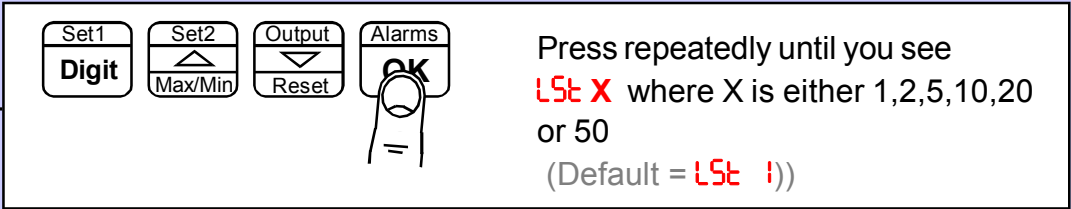
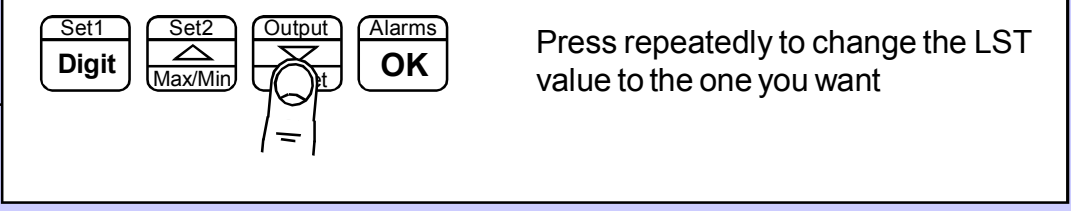
This feature is available in Easy and Advanced Modes

- 1** — 
- 2** — 
- 3** — 
- 4** — 

Scale Factor adjustment

After you have calibrated your meter, you can use the SCALE feature to make fine adjustments to calibration, without affecting the calibration itself.

!! This feature is available in Advanced Mode only !!

- 1**

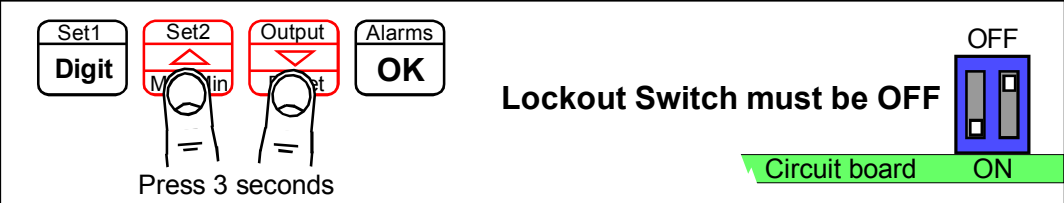

Press 3 seconds

Lockout Switch must be OFF

Circuit board ON
- 2**

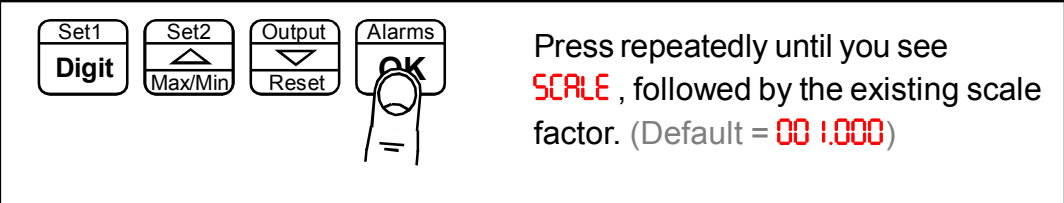

Press repeatedly until you see **SCALE**, followed by the existing scale factor. (Default = **00 1.000**)
- 3**

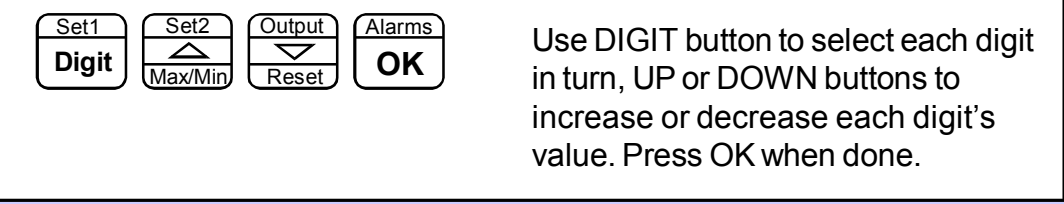

Use DIGIT button to select each digit in turn, UP or DOWN buttons to increase or decrease each digit's value. Press OK when done.
- 4**

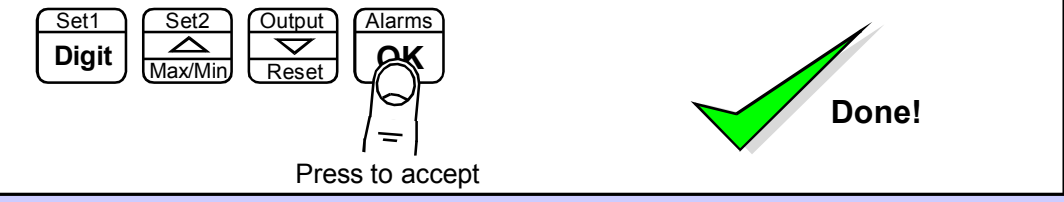

Press to accept



Done!

You may want to adjust an offset value also, see separate OFFSET page for this feature.

Offset adjustment

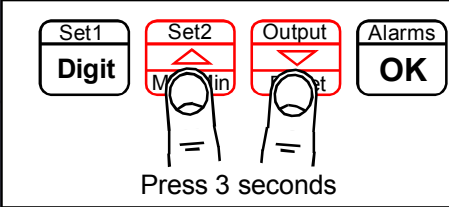

After you have calibrated your meter, you can use the **Offset** feature to make fine additions or subtractions to the reading, without affecting the calibration itself.

!! This feature is available in Advanced Mode only !!

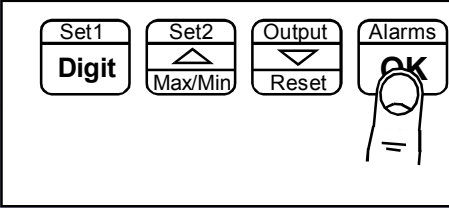
1  **Lockout Switch must be OFF** 

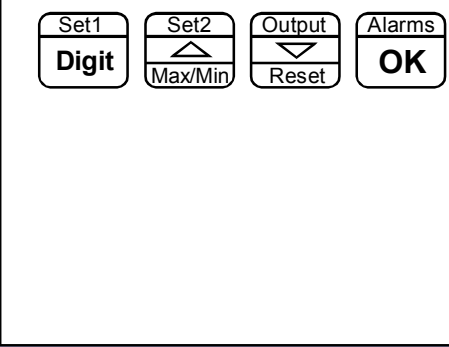
2  Press repeatedly until you see **Offset**, followed by the existing offset value. (Default is **000.000**)

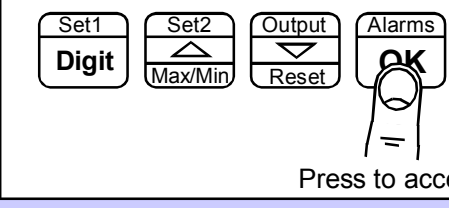
3  Use **DIGIT** button to select each digit in turn, **UP** or **DOWN** buttons to increase or decrease each digit's value. If you want to set a negative value, use **DIGIT** to select the left hand digit, and press the down button to go below 0 to activate the - sign. Press **OK** when done.

4   **Done!**

You may want to adjust a **SCALE FACTOR** value also, without affecting calibration. See the separate **SCALE** page for this feature.

Menu timeout adjustment

The display has a default timeout of 60 seconds, to allow you sufficient time to refer to the manual between key operations.

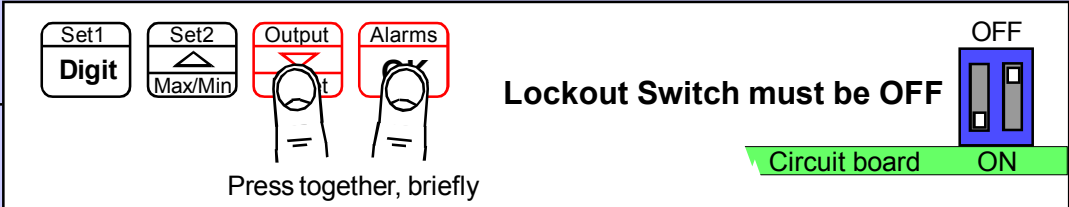

You can make this period shorter, if you wish, once you become more familiar with the setup method.

!! This feature is available in Advanced Mode only !!

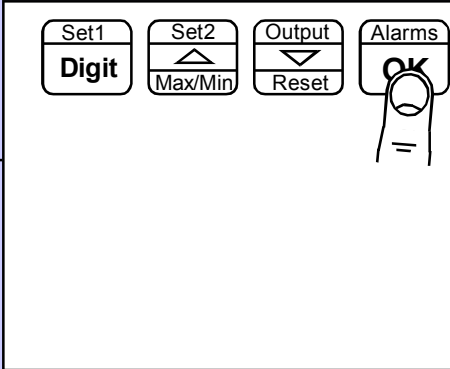
1 —  **Lockout Switch must be OFF**
Press together, briefly

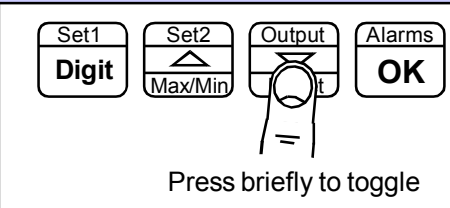
2 —  Press repeatedly until you see **dLAY. XX** where **XX** is the delay in seconds. Choices are ...
dLAY. 10
dLAY. 20
dLAY. 30
dLAY. 60 (default)

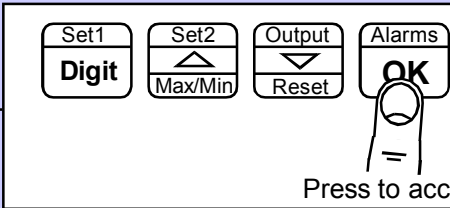
3 —  Press DOWN or UP button briefly and repeatedly to choose from **dLAY. 10** or **dLAY. 20** or **dLAY. 30** or **dLAY. 60**
Press briefly to toggle

4 —  Press to accept  **Done!**

Reverse Display function (mirror image)

If you need to be able to see a reflection of the display in a mirror or other reflective surface, for example in a simple heads-up system, or for drivers reversing into a bay, using mirrors only, you can set the display to show as a mirror image.

!! This feature is available in Advanced Mode only !!

- Lockout Switch must be OFF

Circuit board ON

Press together, briefly
- Press OK button briefly and repeatedly until you see

rEU.d 0 (Default)
or
rEU.d 1
- Press DOWN or UP button briefly and repeatedly to choose from

rEU.d 0 (normal display) or
rEU.d 1 (mirror image display)

Press briefly to toggle
- Press to accept

Done!



Example of normal display format displaying the number 876543



Example of Mirror Reverse display format displaying the number 876543

Bootup routine choices

When you switch on your meter, it can be set to power up with 3 possible summary message combinations.

The choices are:-

- boot 0** = Segment test, followed by a full summary of software revision, calibration audit number, model number, installed options.
- boot 1** = Segment test followed by model number (Default)
- boot 2** = No summary, meter displays the measurement value immediately power is applied.
- boot 3** = Segment test remains permanently enabled. Cleared by pressing any button.

!! This feature is available in Advanced Mode only !!

1

Set1
Digit

Set2
Max/Min

Output
=

Alarms
=

Lockout Switch must be OFF

OFF
ON

Press together, briefly

Circuit board ON

2

Set1
Digit

Set2
Max/Min

Output
=

Alarms
OK

Press OK button briefly and repeatedly until you see **boot 0** or **boot 1** or **boot 2** or **boot 3** displayed.

3

Set1
Digit

Set2
Max/Min

Output
=

Alarms
OK

Press DOWN or UP button briefly and repeatedly to choose from **boot 0** or **boot 1** or **boot 2** or **boot 3**

Press briefly to toggle

4

Set1
Digit

Set2
Max/Min

Output
=

Alarms
OK

Done!

Press to accept



You can trigger the full summary message whenever you want, without having to power the meter off, by pressing and holding the 2 outer buttons (Set1 + Alarms) for more than 3 seconds.

Multi-Program Memory option MEM

The three contact closure inputs on the rear of the meter may be used to call up between 1 to 7 additional meter setup memories (pages), if the MEM option has been installed. This allows you to save up to 8 complete sets of independent calibrations, alarm settings, analogue output settings and serial comms settings.

First decide how many memory pages you want, as this will determine how many logic inputs you will need to use for the addressing. Logic inputs not required for Page Addressing can be used for other functions such as Tare, Reset, Display Hold, Peak/Valley display.

If you have used all 3 logic inputs for Page Addressing, you can still use the meter's front panel buttons to perform Tare, Reset and peak/Valley view.

See "Contact Closure Input Functions" page for CC.1, CC.2, CC.3 and COP settings

Total number of pages	Logic Inputs required for addressing
1	none, standard single page meter
2	1 Set CC.1 = PA.1
3 or 4	2 Set CC.1 = PA.1, Set CC.2 = PA.2
5 to 8	3 Set CC.1 = PA.1, Set CC.2 = PA.2, Set CC.3 = PA.4

1. Set lockout switches OFF, and set page address to 0 or unplug the logic connector.
2. Set the copy instruction to **COP. 1** in page address 0 (found after you set CC3) .
3. Press all 4 buttons together, display shows **dEF5. n**
4. Press the Up arrow to change display to **dEF5. y** and press OK.
5. If you want all channels to share a common setting, eg calibration, do that setting now.
6. When you want to do separate settings for each channel, set COP.0

Programming and recalling individual pages

Plug the logic input connector back in, if you removed it earlier. Select a page address using the switch combinations shown below, wired to the Logic Input connector ...

Page address 0	All logic inputs open
Page address 1	CC.1 closed to Common
Page address 2	CC.2 closed to Common
Page address 3	CC.1 and CC.2 closed to Common
Page address 4	CC.4 closed to Common
Page address 5	CC.1 and CC.3 closed to Common
Page address 6	CC.2 and CC.3 closed to Common
Page address 7	All logic inputs closed to Common

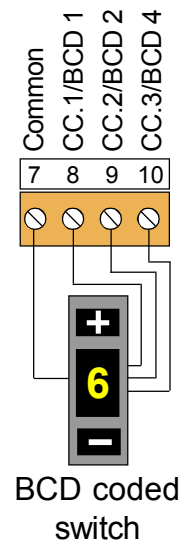

Perform the settings you require, according to the pages in this manual. Do this for all page addresses required. Then put the lockout switch in its ON position. Now, if you select a page address, the meter will briefly confirm the chosen page address on screen, and will then function according to the settings you programmed for that address.

Suitable BCD coded switches are available from many electrical supply stores. For example consider Kraus & Naimer part A540-600 E24 or Apem part number IRBC10N1248 or London Electronics part number SW2P-8W-BCD, which also provides separate 2 pole 8 way signal selection function.

Error codes and fault finding



1. Under Range. The meter is being asked to display a value which is more negative than its limit of -199999



2. Over Range. The meter is being asked to display a value which is higher than its limit of 999999

How to install option boards



Where the product is intended for "UL" installations removal or addition of option boards is not permitted.



Warning: Disconnect power before you expose the rear of the meter

If you want to open your meter to install or modify option boards, follow these steps...

- 1) Switch off power to the meter and unplug all connectors.
- 2) Unclip the front bezel. This is easier if you squeeze the top and bottom of the case, near the front.
- 3) Remove the small screws shown in the diagram. If the meter doesn't yet have an output option board, the top screw may not yet be fitted.
- 4) Slide the electronic boards out through the front of the case. You can easily separate the upper option board from the main board. We strongly suggest that you use anti-static precautions to prevent damage to the semiconductors.

The board assemblies will look something like this...

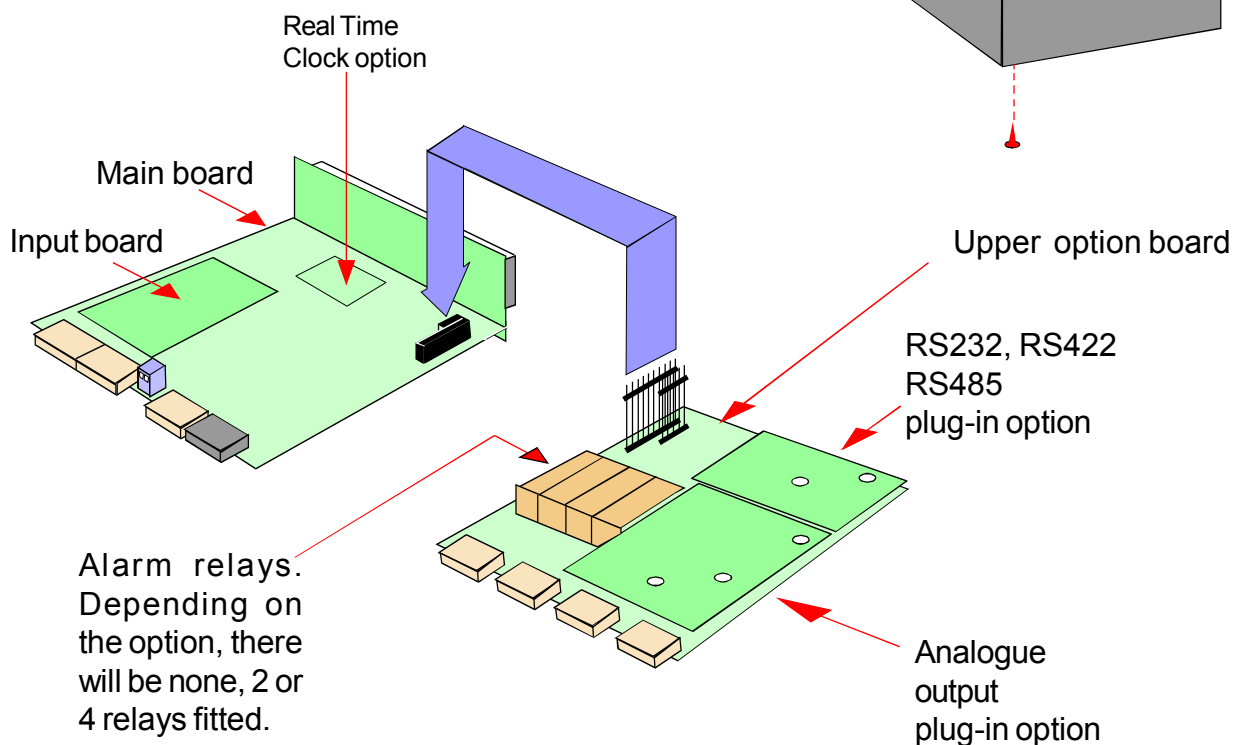

The analogue output and RS232 or RS422 plug-in option boards are fixed to the upper option board with white plastic pillars. You must apply a firm force when fitting or removing these options.

Always be careful to connect the pins to sockets accurately. When reassembling, make sure option boards are firmly fixed to the upper option board. When the boards are replaced in the case, secure them again with the two small black screws.

Waste Electrical Electronic Equipment (WEEE)

In Europe, this equipment must be disposed of in accordance with European Parliamentary Directive 2002/96/EC

This directive encourages recycling and the reduction of waste materials in the environment.

This means it must be sent to an approved recycling plant if you want to dispose of it.

It must not be thrown away with general rubbish.



WEEE Waste Recycling

If you are unable to dispose of this item locally, you may send it to us for recycling.

Conditions:

1. We will only accept items of our manufacture.
2. You must pay for the transport of the goods to us.
3. We will only accept items if they include a signed declaration by an authorised person in your organisation, stating that :-
 - i. The item is safe to handle and has no contaminants which may be harmful to health.
 - ii. You wish us to dispose of or destroy the item(s)

Equipment Specifications

Bezel size	48mm high by 96 mm wide (1/8 DIN)
Panel Cutout	45 mm high by 92 mm wide
Case Depth	125 mm including connectors
Weight	300 grammes
Case Material	Black polycarbonate
Connectors	Detachable Screw Terminal connectors
Environmental	Storage Temperature range -20 to +70C, non condensing Operating temperature range 0 to 50C, non condensing Front sealed IP65. Optional cover SPC4 for IP67
Power Burden	100-240 VAC, 45 to 60Hz or 11-30 VDC optional 10VA maximum
Input Signals	2 wire screened connection, 0 to 10 000 Megohms Measurements are presented from 5 Megohms to 10 000 Megohms in nanoSiemens (conductivity) Below approximately 5 Megohms, the display will show -- or -- meaning over-range.
Accuracy	+/- 1% of range. Allow 30 minutes for meter to achieve thermal equilibrium
Filtering / smoothing A/D conversion	Selectable time constants of 0 to 25 seconds. Sigma-Delta 10 conversions per second, 50/60Hz rejection Resolution 1 in 400 000 max. over full range
Display update rate	10 readings per second.
Display Range (max)	-199999 to +199999, depending on available signal level.

Plug-In Output Options

Analogue O/P	See analogue output manual for details. Available on our website.
Alarm Relay O/P	See alarm output manual for details. Available on our website.
ASCII Data O/P	See Serial output manual for details. Available on our website.
Calendar/Clock option	See serial output manual for details. Available on our website.

Record of Revisions

10 September 2010	Version F0.18 Software released. Manual format revised to improve clarity and segregate easy from advanced menu functions. Optional outputs now described in their own dedicated manuals. DIN Rail mounting option added. Cabling guidance added.
8 February	Version F00.21 software released.
28 February 2011	Warranty increased to 3 years and terms added.

Declaration of CE Conformity

Declaration Reference : INTUITIVE Mk2
Issue Date : 30 April 2007
Products Covered : INTUITIVE Mk2 series
Title : DOC-INTUITIVE2

This is to confirm that the Product covered by this declaration has been designed and manufactured to meet the limits of the following EMC Standard :

EN61326-1:1997

and has been designed to meet the applicable sections of the following safety standards

EN61010-1:2001



Conditions

The meters are permitted a worst case error of 1% of A/D range during electro-magnetic disturbance, and must recover automatically when disturbance ceases without the need for human intervention, such as resetting, power-down etc.

The meters covered by this certificate must be installed in adherence to the following conditions :-

Signal cabling shall be routed separately to power carrying cabling (includes relay output wiring)

All signal cabling shall be screened. The screen shall only be terminated to the power earth terminal at the meter end of the cable.

Declared as true and correct, for and on behalf of London Electronics Ltd.

J.R.Lees Director