

# London Electronics Limited

Thorncote Road, Near Sandy, Bedfordshire SG19 1PU  
Tel +44(0)1767 626444 Fax +44(0)1767 626446  
www.london-electronics.com help@london-electronics.com

## Panel mounting differential process indicator

# INT2-P-DIFF

## 2 x 0-10V Version

### Connection details, scaling and general information



**Caution:** There is a risk of electrical shock if this instrument is not properly installed



**Caution:** Risk of danger: Read the whole manual before you install this meter



**Ordering code: INT2-P-DIFF-X-X-X-X-X-X**

**INT2** = Intuitive Mark 2 family

**P-DIFF** = Process differential model

Analogue output: — **0**=none, — **ANB**=-10to+10V, — **ANI**=4-20mA, — **ANV**=0-10V

Alarm outputs: — **0**=none, — **AL2**= 2 relays, — **AL4**=4 relays

Serial data: — **0**= none, — **232**=RS232, — **485**=RS485

Display colour: — **R**=Red, — **G**=Green

Power: — **AC**=100-240V AC, — **DC**=11-30V DC

Mounting: — **0** = Standard panel **DIN** = DIN rail mounting

**Software version F00.18**

Document Ref:pm65\manuals\INT2\_P Revision:17 Dated: 6 September 2010



# Contents

Warnings	4
Introduction	5
General Description	6
Panel mounting & Installation - Class II	7
DIN Rail mounting option	8
Other Mounting options	9
Wiring Advice	10
Connections	11
Installation hints for best performance	12-13
Easy/Advanced menu mode	14
Language Selection	15
Display Brightness	16
Display Calibration Modes	17
Direct Calibration	18-19
Linearisation with Direct Calibration	20-21
Theoretical Calibration	22-23
Linearisation with Theoretical Calibration	24-25
Sensor Drift correction	26
Logic Input functions	27
Logic Input connections & Front Buttons	28
Factory defaults	29
Calibration Audit number	29
Signal Filtering / Averaging	30-31
Last Digit rounding	32
Scale Factor adjustment	33
Offset Adjustment	34
Menu Timeout adjustment	35
Reverse / Mirror display setting	36
Bootup Routine choices	37
Multi Memory MEM option	38
Error Codes	39
Output Options - installing	40
WEEE	41
Equipment Specifications	42
Record of Revisions	43
Declaration of Conformity	44

## **Separate manuals for options**

Alarm option settings	See Alarm manual *
Analogue output option settings	See Analogue manual *
Serial output option settings	See Serial manual *
Real Time Clock setting	See Serial manual *

\* Need a manual urgently?

You can download manuals from <http://www.london-electronics.com/manuals/>

# Warnings

Please carefully read this manual and all warnings. Install the meter ONLY when you are sure that you've covered all aspects.



Where the product is intended for "UL" installations, removal or addition of option boards is not permitted.



Check that the model number and supply voltage suit your application before you install the meter.



Connect the meter according to current IEE regulations, IEC61010 & NFPA:70 National Electric Code in USA.



This meter is for Installation class II service only. This means it has exposed electrical and power terminals. You must install it in a suitable fire enclosure which will also protect users from electric shock



We designed this meter for Pollution-Degree 2 environments only.



Power supplies to this equipment must have anti-surge (T) fuses rated at 400mA for 230V supply, 400mA for 110V supply or 2A for DC supplies in the range 11-30VDC. Only Siba fuses in series 189500, cULus listed according to file #E167295 are accepted for this service under the terms of UL listing. A switch or circuit breaker, clearly marked as a disconnecting device, must be included close to the installation.



Don't touch any circuitry after you have connected the meter, because there may be lethal voltages on the circuit board.



Only adjust on-board switches or connections with the power turned off



Make sure all screw terminals are tight before you switch the meter on.



Only clean the meter's front with a soft damp cloth. Only lightly dampen with water. Do not use any other solvents. The behind-panel case may be cleaned with a dry cloth only, use no liquid or solvent on it.

**Safety First .....Don't assume anything..... Always double check.  
If in doubt, ask someone who is QUALIFIED to assist you in the subject.**

# Introduction

Please contact us if you need help, if you have a complaint, or if you have suggestions to help us improve our products or services.

If you contact us about a product you already have, please tell us the full model number and serial number, so that we can give you accurate and fast help.

This product has a 2 year warranty. We will put right or replace any meter which is faulty because of bad workmanship or materials. This warranty does not cover damage caused by misuse or accident.

If you return a unit for repair, please include a detailed description of the problem, and the name of a contact who we can refer to for any questions. Please mark for the attention of the QA Department.

## **IMPORTANT**

If this equipment is important to your process, you may want to buy a spare to cover possible failure or accidental damage in the future.

This is because during factory shutdown periods, you may have to wait several weeks for an equivalent replacement, or we may have no stock at the time you urgently need it.

You may also need to pay extra carriage charges if you want a fast, guaranteed courier service. Warranty repairs or replacements are usually returned with a standard courier service.

We do not offer compensation for losses caused by failure of this instrument.

If you do not agree with these conditions, please return this item in unused, condition, in its original packaging and we will refund the purchase price, excluding any carriage paid.

We thought you'd prefer to know about possible delays and extra charges now, rather than during a panic. A spare unit could help to avoid these issues.

We always try to improve our products and services, so these may change over time. You should keep this manual safely, because future manuals, for new designs, may not describe this product accurately.

We believe these instructions are accurate, and that we have competently designed and manufactured the product, but please let us know if you find any errors.

# General Description

This series of meters accepts industrial sensors to allow various physical measurements to be made, such as weight, temperature, pressure, humidity etc. Different models are available for different sensor types.

The main function of this series is to give a numeric readout of the variable being monitored. Most models include an excitation power output, to power the sensor directly.

Various optional output modules are also available to give alarm relay outputs, analogue output or digital communications, or any combination of these options.

Meters are programmed using front panel pushbuttons. The buttons may be locked with a rear switch.

Meters have two power supply options : 100-240 VAC or 11-30VDC

These meters are designed to mount into a protective enclosure which will protect users from contact with power and signal wiring.

These units must be installed fully assembled, and must be installed according to local electrical installation rules. When properly installed, they provide ingress protection to IP65 / NEMA4X from the front

## Safety



**Caution:** There is a risk of electrical shock if this instrument is not properly installed



**Caution:** Risk of danger: Read the whole manual before you install this meter

Obey all safety warnings in this manual, and install the meter according to local wiring and installation regulations. Failure to follow these guidelines may cause damage to the meter, connected equipment, or may be harmful to personnel.

Any moving mechanical device controlled by this equipment must have suitable access guards to prevent injury to personnel if the meter should fail.

# Panel Mounting and Installation - Class II

Install the meters in a suitable protective electrical control enclosure according to local wiring regulations. See specifications for maximum allowable temperature in enclosure. Allow adequate air circulation.

**Installing into front of panel**  
 Remove the two rear bracket screws and safely store them and the U-Bracket for later fitting.

92mm +1mm -0mm  
 45mm +1mm -0mm  
 Panel cutout  
 Gasket  
 Slide the meter, with gasket into the panel cutout  
 Bracket screws  
 U-Bracket

**Securing into the panel**  
 Re-fit the U-Bracket and tighten the bracket screws to firmly clamp the meter in place. Check that the gasket is evenly pinched between the meter's front bezel and the enclosure front.

**Ventilation**  
 There should be sufficient ventilation in the enclosure to ensure that the meter's case is always kept to less than 60C.

**Meter Spacing.**  
 Meters should be spaced apart sufficiently to allow a free flow of ventilation air around the meters, such that no part of the case will exceed 60C

U-Bracket  
 Bracket screws  
 Front surface of enclosure

**Side view of meter installed in panel**

Bracket screw (1 of 2)  
 Left side of meter case  
 U-Bracket  
 Gasket  
 Front surface of enclosure  
 Front surface of meter

## DIN Rail Mounting option

The INT2 Series is ideal if you need high precision signal conditioning. Sometimes, it is not necessary to have front panel indication, so in such cases, we offer a DIN rail mounting option, which allows the INT2 to be installed within a control panel.

Detachable connectors add to the simplicity of installation, and of course the setup method is identical to the panel mounting version, so you don't need to learn a new method.

The INT2's display remains active, so you can see at a glance the status of your signals, and programming is simple, using the 4 buttons.

Output functions include isolated 16 bit 4-20mA, 0-10V, -10 to +10V, RS232, RS485 and up to 4 alarms with a wide choice of alarm functions.

Install the meters in a suitable protective electrical control enclosure according to local wiring regulations. See specifications for maximum allowable temperature in enclosure. Allow adequate air circulation.

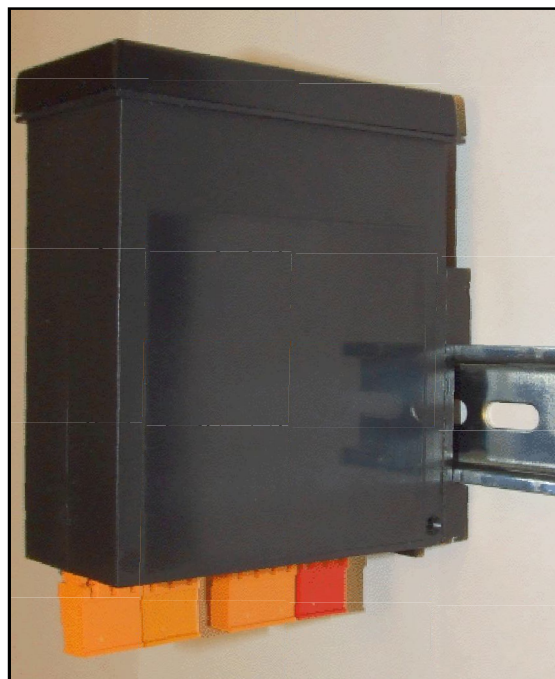

### Securing into the panel

Use standard top-Hat DIN rail 35 mm x 7.5 mm (EN 50022, BS 5584, DIN 46277-3)

### Ventilation

There should be sufficient ventilation in the enclosure to ensure that the meter's case is always kept to less than 60C.

### Meter Spacing.

Meters should be spaced apart sufficiently to allow a free flow of ventilation air around the meters, such that no part of the case will exceed 60C



## Other mounting options

### IP67 SPC4

The SPC4 splashproof cover gives IP67 / NEMA4-X protection for the front of your meter. Ideal for use in harsh wet environments.

Available with optional security tag ports to allow you to fit your own crimped wire tamper-seals, to prevent or indicate unauthorised access (Similar to tags used on electricity meters)

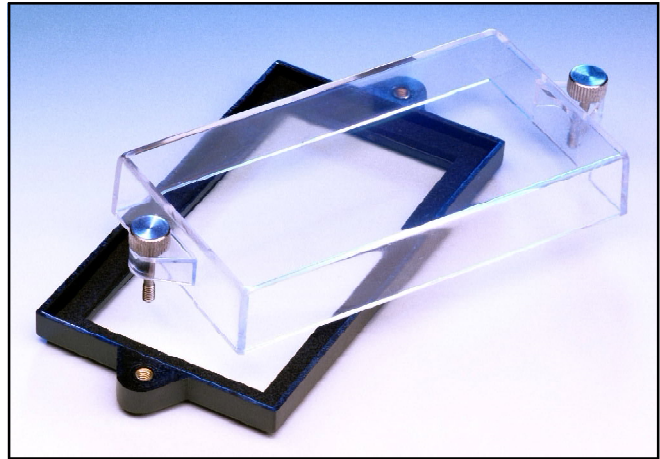

### Wall Box

The Wallbox is sealed IP65 all round, and is supplied with the meter installed, for you to wire to, via 3 cable glands. It comes complete with SPC4 splashproof cover.

We also offer a dual version of this enclosure, which can take 2 meters, one above the other.



### PCC Series

The PCC series of Portable Carrying cases is ideal for housing your panel meters so that they can be used in the lab. These enclosure come fully wired, with panel meters fitted and with IEC switched power connector plus any input or output connectors, as required.

Versions are available to accept 1, 2, 4, 6, 8, 12 or 16 meters



# Wiring Advice

This meter uses detachable screw terminal connectors. Refer to the wiring diagram on the following page for the correct positioning of each wire.

The conductors you use must be suitable for the meter's temperature, current and voltage rating, which is broadly described as follows:-

## Cable Temperature Rating

All cables must be rated for operation up to 90C continuous.

## Cable gauge and screw tightness

The connectors on this instrument can accept conductors up to 16 gauge AWG / 1.5mm<sup>2</sup> c.s.a. The minimum cross sectional area shall be 22 gauge AWG / 0.5mm<sup>2</sup>. Tighten screw terminals to 7.0 lb/in torque / 0.8 Nm torque.

## Cable insulation voltage rating

Cables shall have an insulation voltage rating of at least 380V continuous.

Wire preparation:

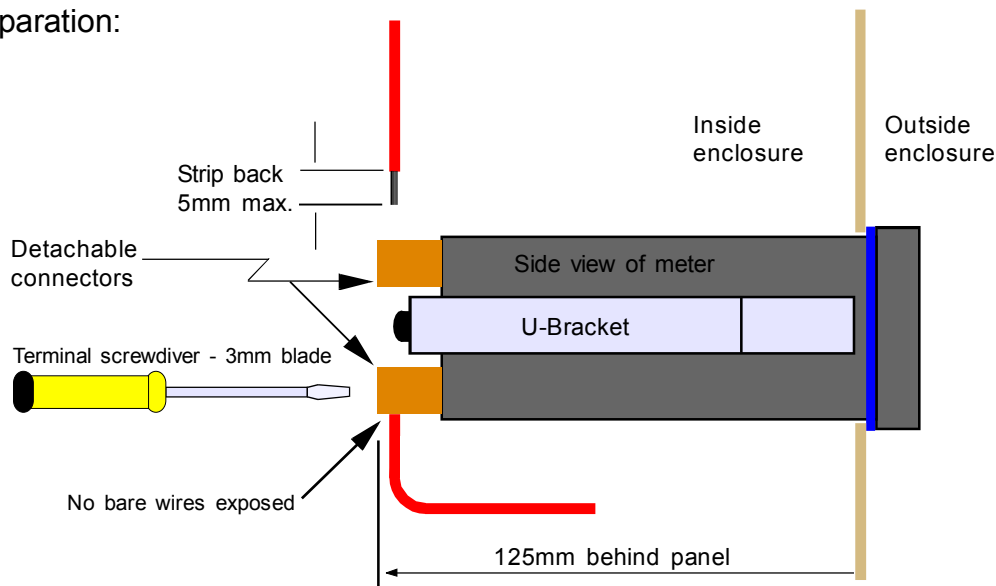

We recommend multi-strand wire, because it withstands vibration better than single strand cable. Pull the wire firmly after you make the connection to confirm it is tight.

Use screened cable for all signal and control wiring and connect the screen to earth at the destination end only. Route signal cabling away from power cabling and relay switching cabling, to avoid electrical noise interference.

# Connections

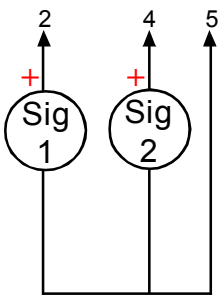
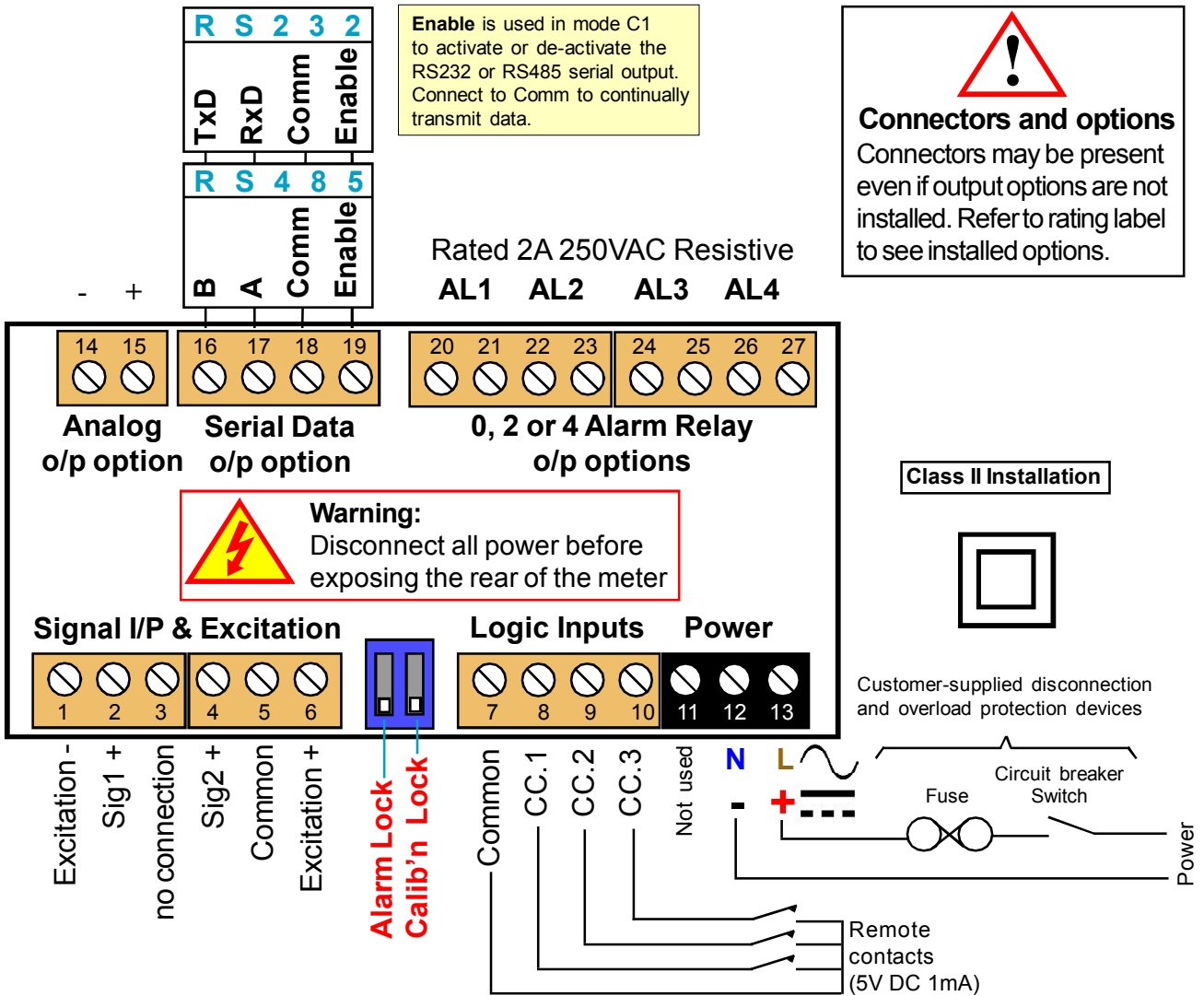

Display = Sig2 - Sig1

# Installation hints for best performance

This section offers several suggestions which will help you get the best performance from your measurement system.

Some sensors generate comparatively small signals which can easily be corrupted by the potentially high level of electrical noise which can be created by electrical machinery such as motors, welding systems, discharge lighting, AC power inverters and solenoids. These steps will ensure you get the best possible performance from your system.

1. Use good quality screened signal cable, with twisted pairs. Belden 8777NH, Belden 9503 and AlphaWire 6010C are good choices, available from many electrical distributors.
2. If you are using multi-pair twisted cable, each pair should be dedicated to a single display as shown opposite, for maximum noise immunity. This will ensure that any electrical noise induced in the cable is properly cancelled. Mixing destinations carelessly amongst the twisted pairs can actually worsen noise performance.
3. The cable should be routed away from noisy wiring and devices such as power feeds from inverters, discharge-lighting cables, welder cabling etc, and should preferably be routed in a dedicated low voltage signalling/instrumentation conduit or cable tray.
4. Screened cable should be earthed at the display end only.
5. All wires and screens coming out of the screened cable should be kept as short as possible to minimise pickup of noise.
6. If you are using barriers, you should earth your screen as shown below, paying particular care that you do not earth both ends of any run of of cable.

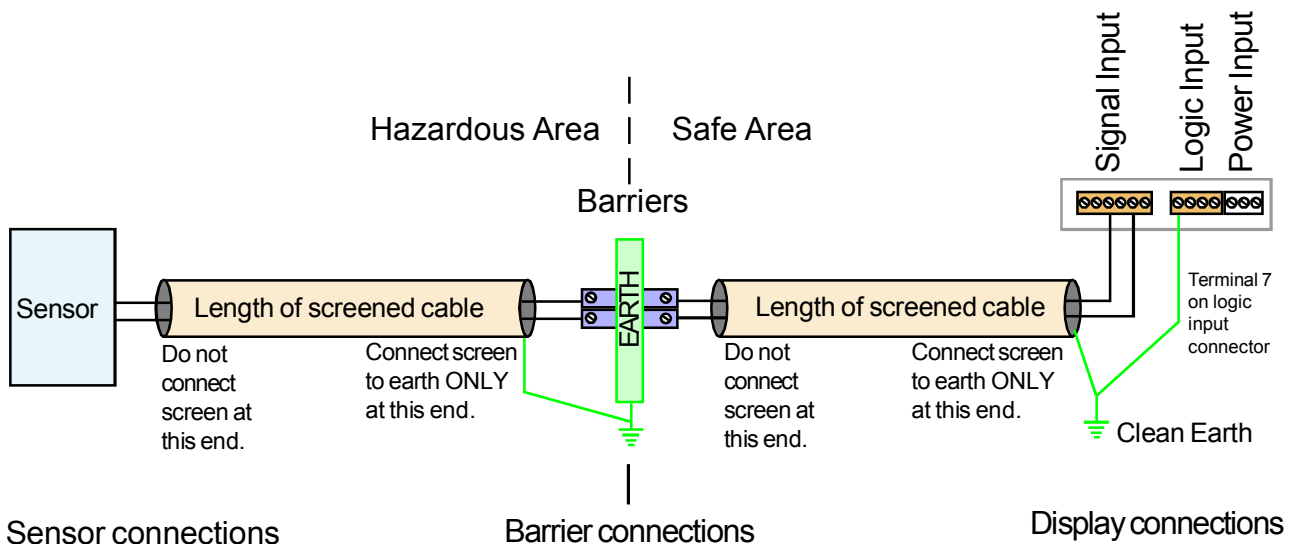

When using multi-core screened cable to connect several displays to several sensors, please be sure to use one twisted pair for each display and sensor.

Do NOT use a wire from one pair for signal positive and a wire from another pair for signal negative, as this will prevent the twisted cables from cancelling any induced electrical noise.

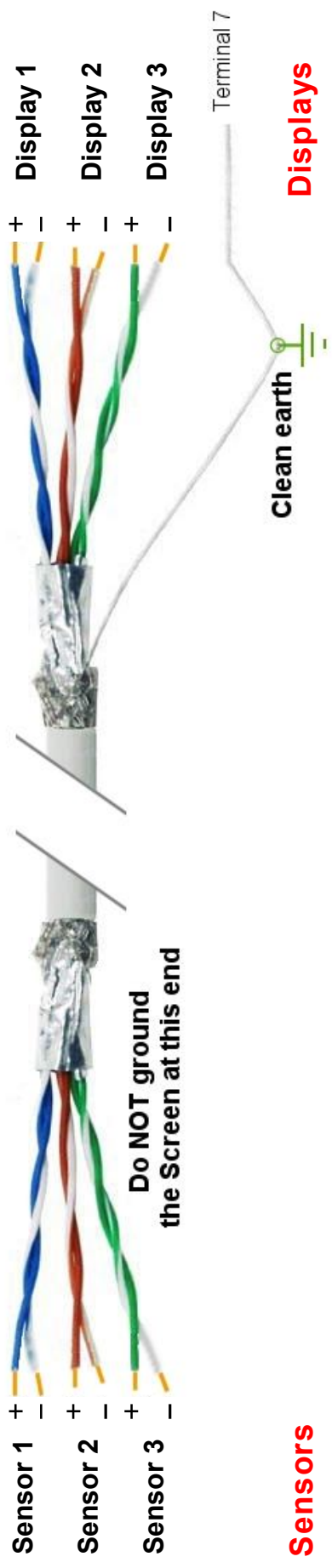

# Easy or Advanced menu mode

You can choose from two menu modes.

**1. Easy Mode** - This limits the menu to the most commonly required features, in order to make it less complex and easier to navigate. This is the default level.

**2. Advanced Mode** - This gives you access to all available menu features.



Each menu feature in this manual has a heading note to tell you whether it is available in Easy or Advanced mode.

How to choose menu mode:-

**This feature is available in Easy and Advanced Modes**

- Lockout Switch must be OFF   
Circuit board ON

Press together briefly
- Press OK a few times, until you see **Adv.** or **EASY**

Press briefly
- Each press of the DOWN arrow, or UP arrow will alternate between showing **Adv.** or **EASY**

Press to toggle
- Press OK to select your choice.

Press to accept

**Done!**

# Language Selection for user interface

You can select English or French menu prompts.

**This feature is available in Easy and Advanced Modes**

**1**

Set1 Digit    Set2 Max/Min    Output    Alarms    Lockout Switch must be OFF    OFF

Press together, briefly

Circuit board ON

**2**

Set1 Digit    Set2 Max/Min    Output    Alarms OK

Press to toggle

Display shows

UI Eng (Default)  
for User Interface English  
or  
UI Fr-FR  
for User Interface French

**3**

Set1 Digit    Set2 Max/Min    Output Reset    Alarms OK

Press to accept

Done!

# Display Brightness

You can adjust the display brightness at any time, provided the display is locked.

**This feature is available in Easy and Advanced Modes**

- 1**

Press 3 seconds

Lockout Switch must be ON

Circuit board ON

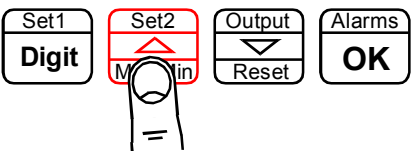
- 2**

Press for 3 seconds

Display shows **br ight**

Each press of the UP button will select a new brightness level. There are 7 brightness levels to choose from. (Default = Full brightness)

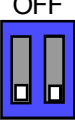
- 3**

Press to accept

Done!

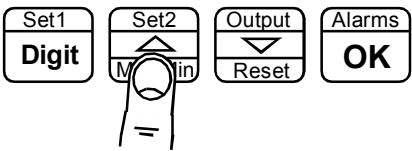



Did you know, we make this display in two brightness versions? Standard brightness for use inside, and Daylight Viewing for use outside in direct sunlight. The Daylight Viewing version has suffix -DLV in its part number.



# Meter Calibration Modes

You can choose from two main calibration methods.

**1. Direct Calibration** - this is when you connect the meter to your system and make the meter read what you want it to, at 2 different points. *This is the preferred calibration method, because it allows you to calibrate the system as a whole.*

**2. Theoretical Calibration** - this is when you type in the sensor's theoretical signal level at the bottom and top of its range and then type in the value the display should show, for each signal level.

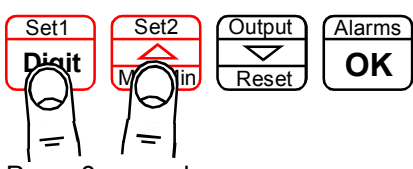
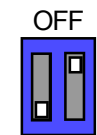

How to choose a calibration method:-

**This feature is available in Easy and Advanced Modes**

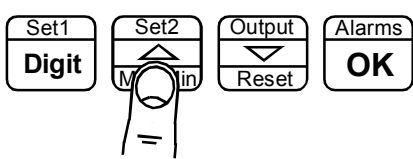
- 1**  **Lockout Switch must be OFF**  **Circuit board ON**

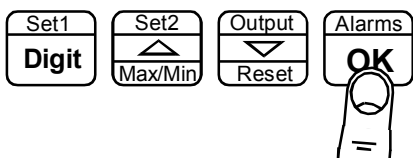
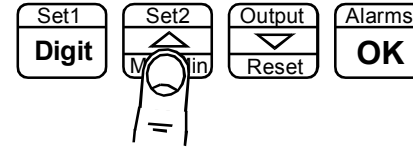
Press 3 seconds
- 2**  Display shows **CAL Src** then **dirECT** or **thEor** (Default)

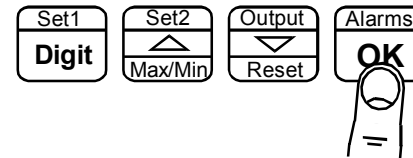
Press to select dirECT or thEor
- 3**  Press to accept
- 4**  Display shows **inPUt** then **dC A** for current or **dC U** for voltage (Default)

Press to select **dC U**
- 5**   **Done!**

Press to accept

If you chose Theoretical, you will now be asked whether your input signal will be DC Current or DC voltage ... the display will show **inPUt** followed by **dC A** or **dC U**

# Direct Calibration - Full Scale Setting

This is when you connect the meter to your system and make the meter read what you want it to, at 2 different points. *This is the preferred calibration method, because it allows you to calibrate the system as a whole.*

How to do direct calibration:-

If you have not done so before, please select Direct Calibration mode from the previous page.

First we recommend you set the **FULL SCALE** calibration ...

**This feature is available in Easy and Advanced Modes**

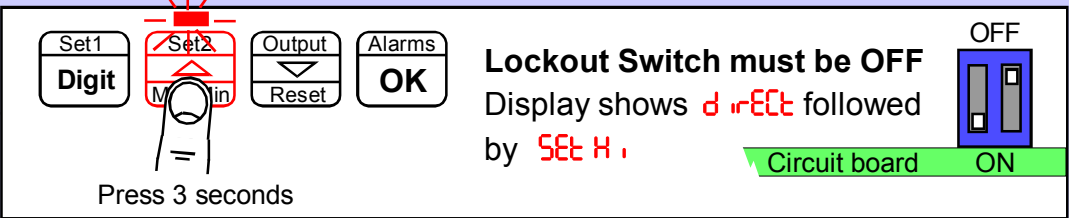
- 

1 — Press 3 seconds

**Lockout Switch must be OFF**

Display shows **Direct** followed by **Set H**.

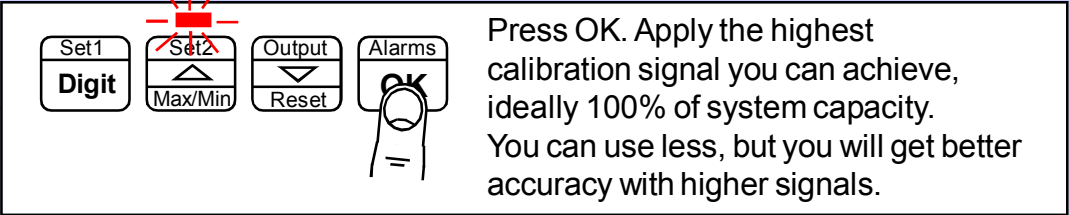
Circuit board **ON**
- 

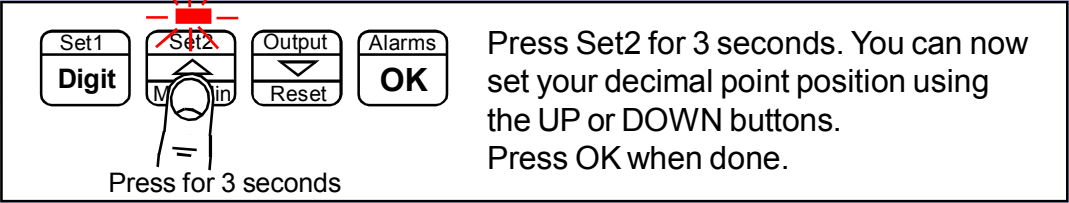
2 — Press OK. Apply the highest calibration signal you can achieve, ideally 100% of system capacity. You can use less, but you will get better accuracy with higher signals.
- 

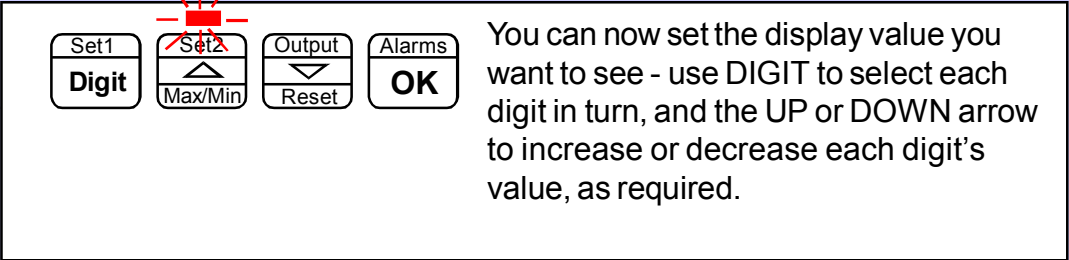
3 — Press Set2 for 3 seconds. You can now set your decimal point position using the UP or DOWN buttons. Press OK when done.
- 

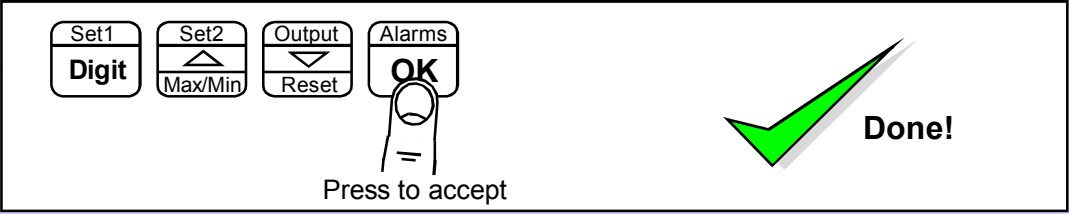
4 — You can now set the display value you want to see - use DIGIT to select each digit in turn, and the UP or DOWN arrow to increase or decrease each digit's value, as required.
- 

5 — Press to accept

**Done!**

# Direct Calibration - Zero Setting

How to calibrate the **ZERO** point.

**This feature is available in Easy and Advanced Modes**

- 1**

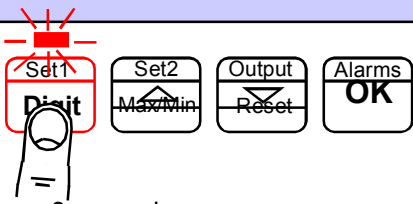

Press 3 seconds

**Lockout Switch must be OFF**

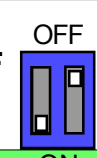

Circuit board ON
- 2**

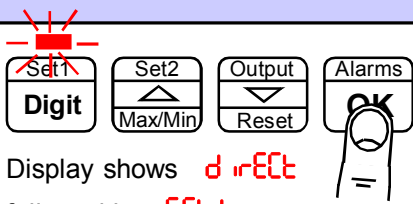

Display shows **dIRECT** followed by **Set Lo**

Press OK. Apply the lowest calibration signal you can achieve, ideally 0% of system capacity.
- 3**

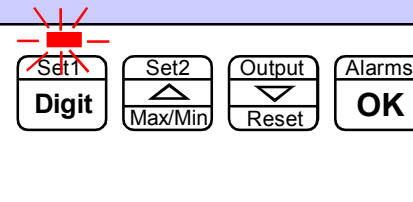

You can now set the display value you want to see - use DIGIT to select each digit in turn, and the UP or DOWN arrow to increase or decrease each digit's value, as required.
- 4**

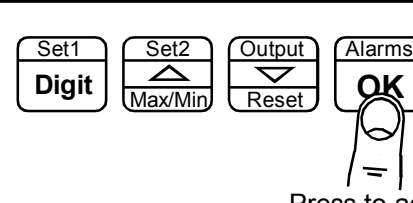

Press to accept

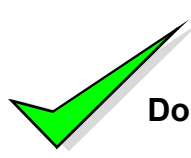

**Done!**

You can set Zero first, if you prefer, but you will not be able to change the decimal point position in the ZERO calibration step.

This will not be an issue if your zero calibration reading is 0, but may become confusing otherwise.

When you have finished your calibration, please remember to put the calibration lockout switch in its ON position, to protect your settings.

# Linearisation with Direct Calibration

If your system is non linear, you can calibrate the meter and correct for this with the lineariser function.

You will need to apply a series of known loads, starting at 0 and working up to full scale. You will then tell the meter what it should read for each applied load. You can use up to 10 points.

First, you must select Direct Calibration Mode (see page on calibration Modes)  
Then, proceed as shown below...

**This feature is available in Easy and Advanced Modes**

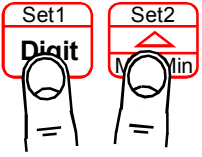
- 

Press together, briefly

**Lockout Switch must be OFF**

Display will show **L in.0n** or **L in.OFF** (Default)

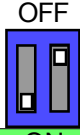

Circuit board **ON**
- 

If the display shows **L in.OFF**, press Set2 button briefly so that the display shows **L in.0n**, then press OK
- 

The display will show **Set 00**

Ensure no load is applied to the system and press OK.

The display will now show **rd 00**

You can now tell the meter what it should display for this load.

Select each digit in turn with the DIGIT button, and increase or decrease each digit's value using the UP or DOWN button, until the display is set as required. Press OK when done.
- 

The display will show **Add.Pt**

Press OK

Continued ...

# Linearisation with Direct Calibration - cont'd.

5

Set1 Digit	Set2 Max/Min	Output Reset	Alarms OK
---------------	-----------------	-----------------	--------------

The display will show **Set 01**  
Apply your 1st known load to the system and press OK.

The display will now show **rd 01**  
You can now tell the meter what it should display for this load.

Select each digit in turn with the DIGIT button, and increase or decrease each digit's value using the UP or DOWN button, until the display is set as required. Press OK when done.

6

Set1 Digit	Set2 Max/Min	Output Reset	Alarms OK
---------------	-----------------	-----------------	--------------

The display will show **Add Pt**

Press OK if you want to Add another calibration point, you will repeat the previous steps, each time incrementing "Set XX" and "rd XX" up to Set 09 and rd 09 which are the last available points.

If you want to finish adding points, press Set2 until the display shows **SAVE**, and then confirm by pressing OK

If you want to abort the setup, press Set2 until the display shows **Quit** and then press OK

7

Set1 Digit	Set2 Max/Min	Output Reset	Alarms OK
---------------	-----------------	-----------------	--------------

**Done!**

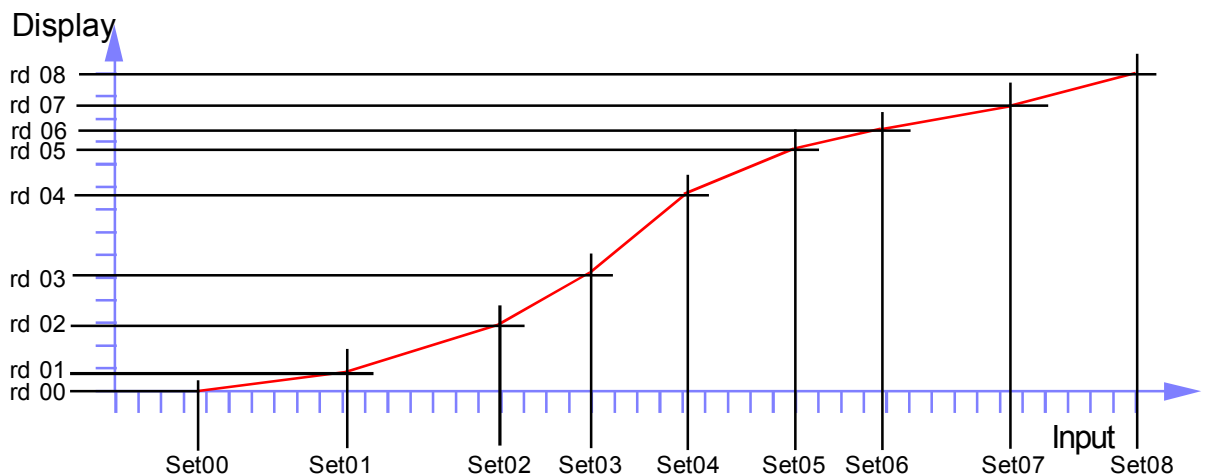

# Theoretical Cal. - Decimal Point & Full Scale

This is when you type in the sensor's theoretical signal level at the top and bottom of its range and the value to display, for each signal level.



If you have not done so before, please select Theoretical Calibration mode from the **Meter Calibration** page AND choose whether your input is current or voltage.

First we recommend you set the **FULL SCALE** calibration ...

This feature is available in Easy and Advanced Modes

- 1

Set1  
Digit

Set2  
Max/Min

Output  
Reset

Alarms  
OK

**Lockout Switch must be OFF**

Press 3 seconds
- 2

Set1  
Digit

Set2  
Max/Min

Output  
Reset

Alarms  
OK

Display shows ~~thEor~~ followed by  
**dC U**, then **In H**.
- 3

Set1  
Digit

Set2  
Max/Min

Output  
Reset

Alarms  
OK

You can now specify the maximum input signal. Use DIGIT to select each digit in turn, and the UP or DOWN arrow to increase or decrease each digit's value, as required. eg set **10.0000** if your input is 0-10V

Press to accept
- 4

Set1  
Digit

Set2  
Max/Min

Output  
Reset

Alarms  
OK

Display now shows **dH**, briefly. You can now specify the maximum reading and decimal point position. Press Set2 button for 3 seconds to set decimal point position. Use up and down arrows to move the decimal point and press OK when done. Then, use DIGIT to select each digit in turn, and the UP or DOWN arrow to increase or decrease each digit's value, as required. eg set 100.000 if your display range is 0 to 100.000

Defaults are

0-10V = 0-100.00 for dC V
- 5

Set1  
Digit

Set2  
Max/Min

Output  
Reset

Alarms  
OK

**Done!**

Press to accept

# Theoretical Calibration - Low end calibration

This is when you type in the sensor's theoretical signal level at the top and bottom of its range and the value to display, for each signal level.

If you have not done so before, please select Theoretical Calibration mode from the **Meter Calibration** page.

**This feature is available in Easy and Advanced Modes**

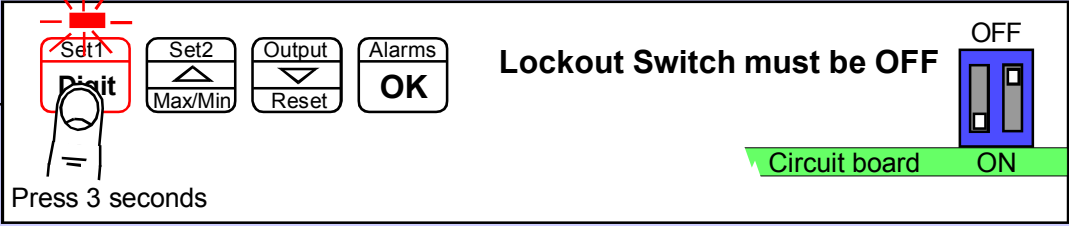
- 

Press 3 seconds

Lockout Switch must be OFF

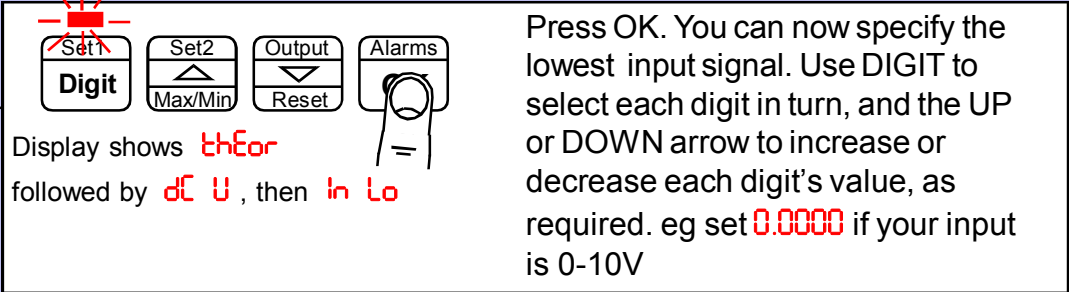
Circuit board ON
- 

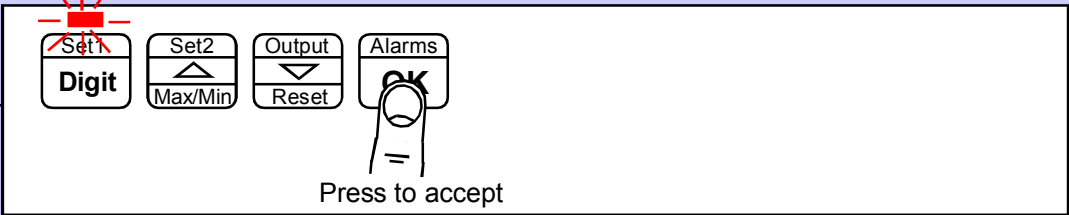
Press OK. You can now specify the lowest input signal. Use DIGIT to select each digit in turn, and the UP or DOWN arrow to increase or decrease each digit's value, as required. eg set 0.0000 if your input is 0-10V
- 

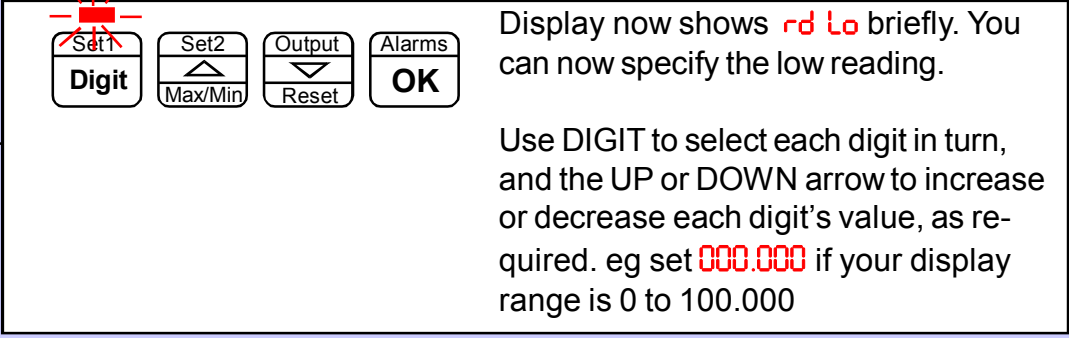
Press to accept
- 

Display now shows rd Lo briefly. You can now specify the low reading.

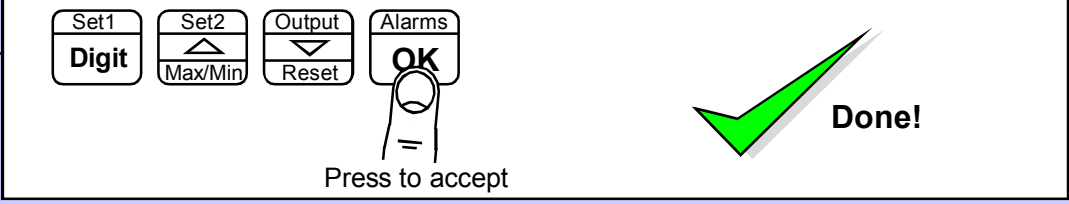
Use DIGIT to select each digit in turn, and the UP or DOWN arrow to increase or decrease each digit's value, as required. eg set 000.000 if your display range is 0 to 100.000
- 

Press to accept

Done!

You can set Zero first, if you prefer, but you will not be able to change the decimal point position in the ZERO calibration step. This will not be an issue if your zero calibration reading is 0, but may become confusing otherwise.

# Linearisation with Theoretical Cal.

If your system is non linear, you can calibrate the meter and correct for this with the lineariser function.

With this method, you can enter theoretical values for input signal and display values, without having to connect a sensor.

First, you must select Theoretical Calibration Mode (see page on calibration Modes) Then, proceed as shown below...

**This feature is available in Easy and Advanced Modes**

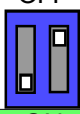
- 

**Lockout Switch must be OFF** OFF  
Display will show **L in.0n** or **L in.OFF**  
Circuit board ON

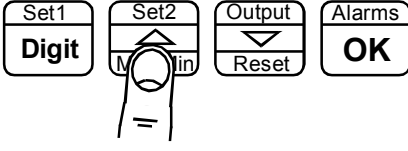
Press together, briefly
- 

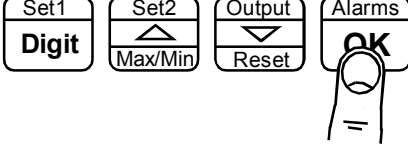
If the display shows **L in.OFF**, press Set2 button briefly so that the display shows **L in.0n**, then press OK
- 

The display will show **ln 00** followed by an editing screen. Here you can enter your first calibration input signal level using DIGIT button to select each digit in turn. Increase or decrease the value of each digit using the UP or DOWN buttons. Press OK when set.

The display will now show **rd 00**  
You can now tell the meter what it should display for this input signal.

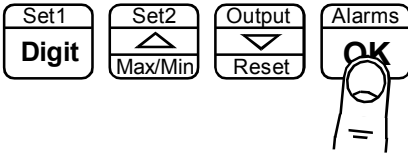
Select each digit in turn with the DIGIT button, and increase or decrease each digit's value using the UP or DOWN button, until the display is set as required. Press OK when done.
- 

Display will show **Add.Pt**  
Press OK

Continued ...



# Linearisation with Theoretical Cal. - cont'd.

5

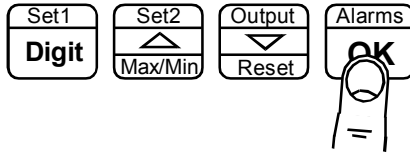
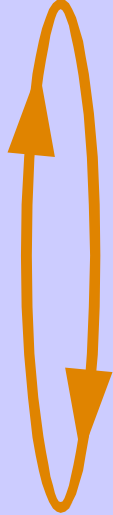

The display will show **In 0!** followed by an editing screen. Here you can enter your next calibration input signal level using DIGIT button to select each digit in turn. Increase or decrease the value of each digit using the UP or DOWN buttons. Press OK when set.

The display will now show **rd 0!** You can now tell the meter what it should display for this input signal.

Select each digit in turn with the DIGIT button, and increase or decrease each digit's value using the UP or DOWN button, until the display is set as required. Press OK when done.

6

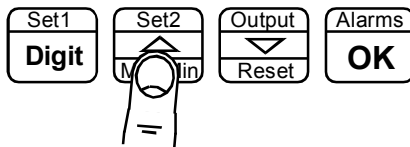

The display will show **Add.Pt**

Press OK if you want to Add another calibration point, you will repeat the previous steps, each time incrementing **In XX** and **rd XX** up to In 09 and rd 09 which are the last available points.

If you want to finish adding points, press Set2 until the display shows **SAVE**, and then confirm by pressing OK

If you want to abort the setup, press Set2 until the display shows **Quit** and then press OK

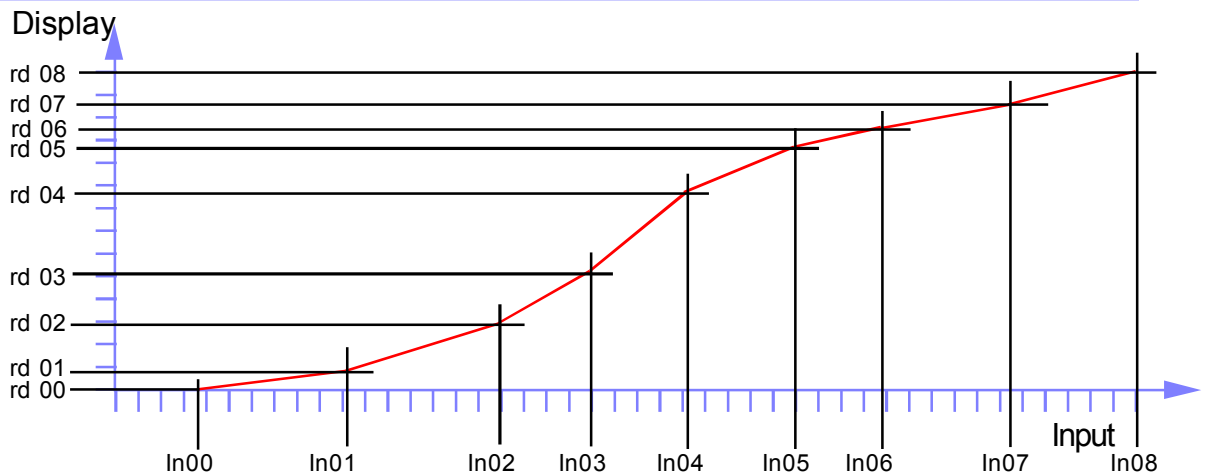
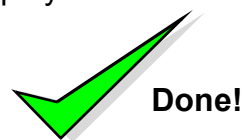

# Sensor Drift correction

If your system is normally reading 0, for example as is typical with platform scales or a torque meter, you may find a small amount of sensor drift caused by changes in temperature, ageing etc.

We can automatically correct for slow, long term drift, by comparing your signal to 0 every 30 seconds, and re-calibrating to remove any detected movement.

This does not affect the sensitivity of your system, and is only applied for readings less than 8 least-significant counts.

The corrected value is stored in non-volatile memory, so that any drift trend will be re-applied after you have switched off the meter.

**This feature is available in Easy and Advanced Modes**

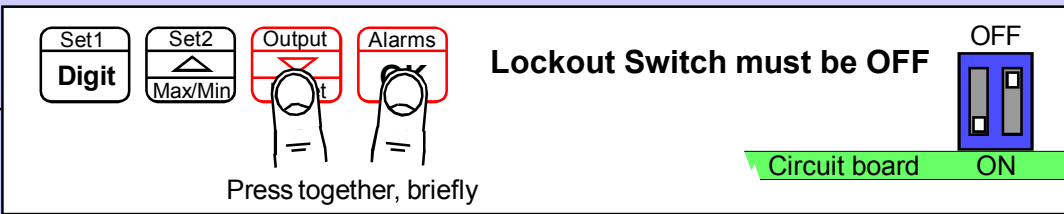
- 

Lockout Switch must be OFF

Press together, briefly

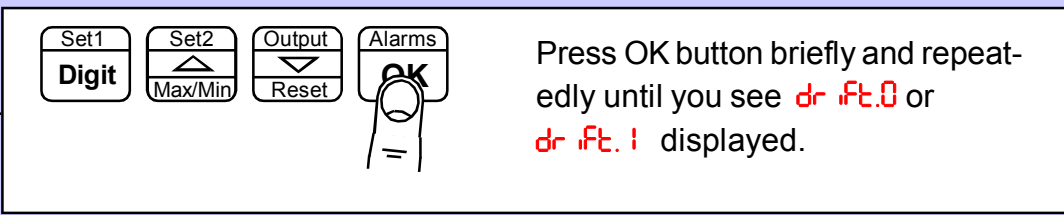
Circuit board ON
- 

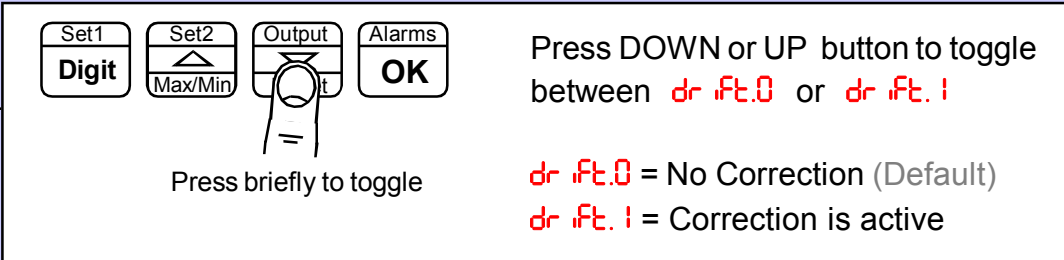
Press OK button briefly and repeatedly until you see **drift.0** or **drift.1** displayed.
- 

Press DOWN or UP button to toggle between **drift.0** or **drift.1**

Press briefly to toggle

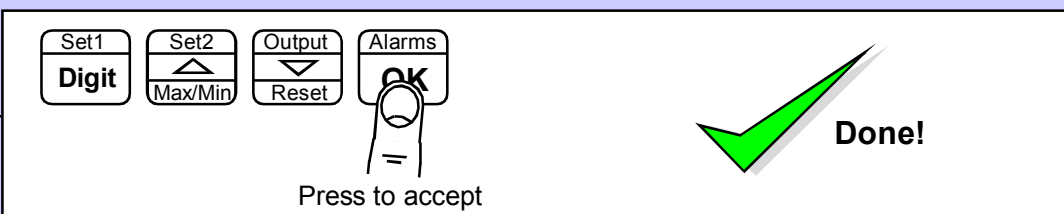
**drift.0** = No Correction (Default)  
**drift.1** = Correction is active
- 

Press to accept

**Done!**

# Logic input functions

The three contact closure inputs on the rear of the meter have default functions which are:-

- Contact closure 1 = Tare
- Contact closure 2 = Peak/Valley display
- Contact closure 3 = Reset

You can re-assign these to include :HOLD, Nett/Gross value display, Memory page address 1,2 or 4 (only if Multi-memory MEM option is installed)

!! This feature is available in Advanced Mode only !!

1

Set1  
Digit

Set2  
Max/Min

Output  
↓  
Reset

Alarms  
OK

**Lockout Switch must be OFF**

OFF

Circuit board ON

Press 3 seconds

2

Set1  
Digit

Set2  
Max/Min

Output  
↓  
Reset

Alarms  
OK

Press repeatedly until you see **CC.1**, followed by the existing function for Contact Closure 1.

After you have set **CC.1**, you will get the prompt **CC.2** to allow you to set Contact Closure 2 function and when you have set CC.2 you will get the prompt **CC.3** to allow you to set Contact Closure 3 function

3

Set1  
Digit

Set2  
Max/Min

Output  
↓  
Reset

Alarms  
OK

Use UP or DOWN buttons to select from these available functions...

Defaults are:-

**CC.1** = TARE

**CC.2** = PU

**CC.3** = rSt

**TARE** = Tare display to 0

**PU** = Peak/Valley toggle

**rSt** = Reset

**HoLd** = Freeze display

**Nett.Gross** = Nett / Gross display

**PA.1** = Page Address 1\*

**PA.2** = Page Address 2\*

**PA.4** = Page Address 4\*

4

Set1  
Digit

Set2  
Max/Min

Output  
↓  
Reset

Alarms  
OK

Press to accept

**Done!**

\* Only available if the Multi-memory MEM option is installed

27

# Logic input connections and front buttons

The previous page explained how to select the functions of the 3 logic inputs. You can connect remote contact closures or open NPN collectors to activate these logic inputs.

The logic input provides a 5V DC signal. When you connect this to common, a current of 1mA will flow. Because this is a small signal, we recommend you use switches with gold plated contacts, or self cleaning contacts, for best long term reliability.

The logic inputs are not galvanically isolated from the input signal.

The logic inputs are only activated when the lockout switch is ON

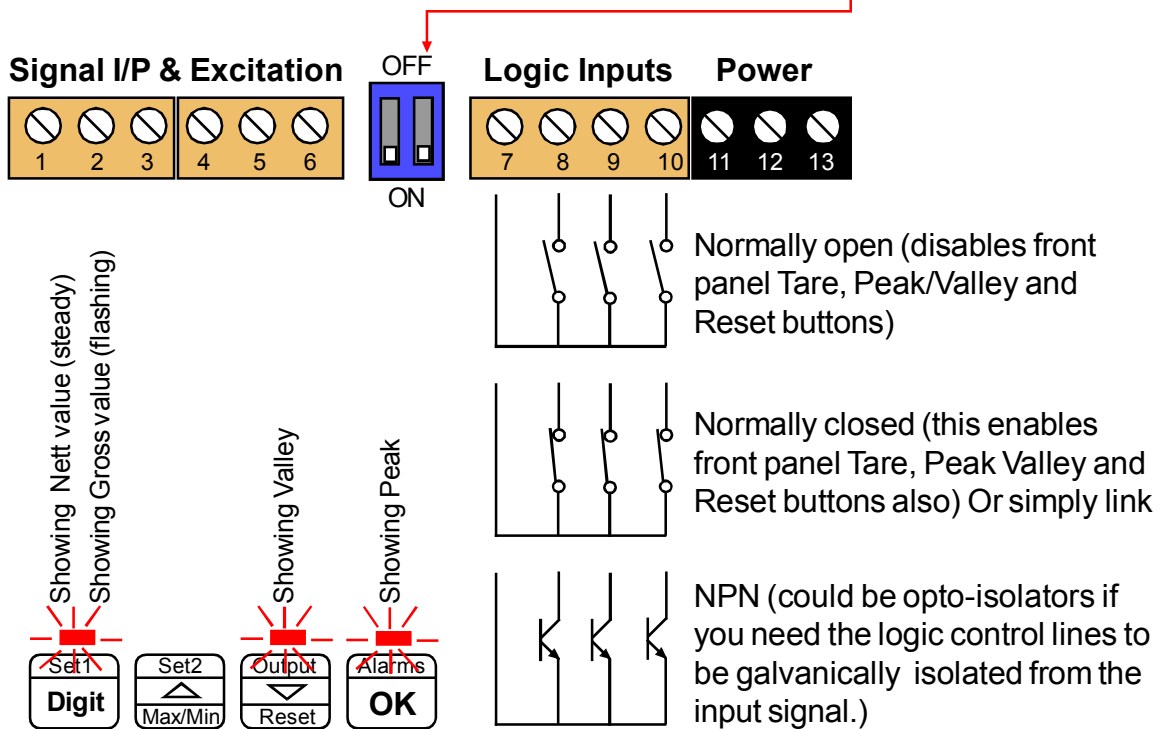

**TARE** = Tares display to 0. Often used in weighing systems to zero a display prior to making a measurement. Net weight is shown once tared. When a display has been tared the small LED above the Set1 button will be illuminated.

**PU** = Peak/Valley toggle. Allows you to view the maximum and minimum values which have been displayed since last reset. 0% LED illuminates when showing valley, 100% LED illuminates when showing peak.

**rst** = Reset. This clears any tare, peak, valley, alarm latch

**Hold** = Freezes the displayed value for as long as the Hold input is closed

**net.gro** = Allows you to toggle between Nett and Gross values on the display

**PA.1 .. 4** = Page Addresses, if MEM option is installed.

# Factory Defaults

You can return the display to its factory default conditions whenever you wish. If you do so, you will permanently lose all your settings and will need to start from the beginning again.

The calibration Audit Counter will NOT be reset, there is no way provided to reset this value, as it is intended as a secure record to indicate whether changes have been made to the display since it was last calibrated..

**This feature is available in Easy and Advanced Modes**

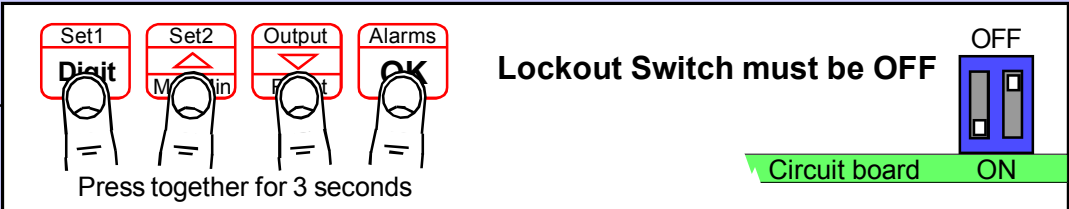
**1** — **Lockout Switch must be OFF**

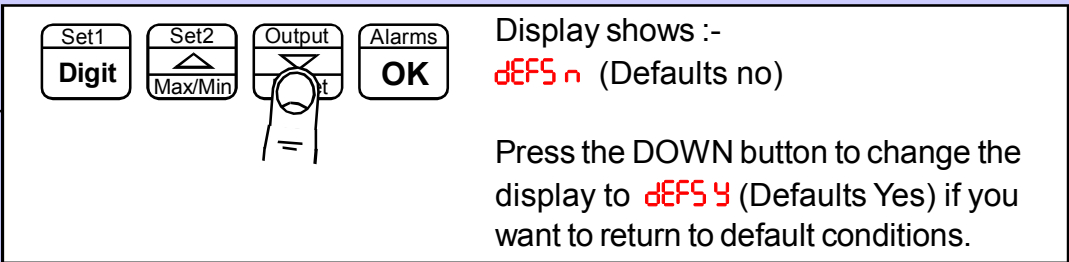
**2** — **Display shows :- dEFS n (Defaults no)**  
Press the DOWN button to change the display to dEFS y (Defaults Yes) if you want to return to default conditions.

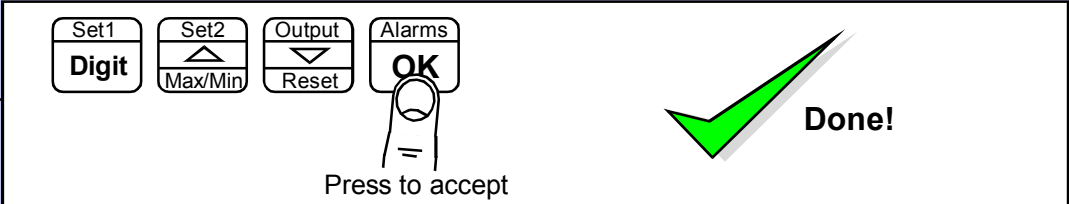
**3** — **Done!**

## Calibration audit number

Your display includes a non-resettable counter which increments each time you make a change to the display's calibration. This is useful if you want to check whether a display has been altered since it was last calibrated.

The Calibration audit number starts at **CAL 01** up to **CAL FF** allowing up to 255 alterations to be recorded. Whenever you want to check the calibration audit number, press and hold the 2 outer buttons (Set1 + Alarms) for more than 3 seconds.

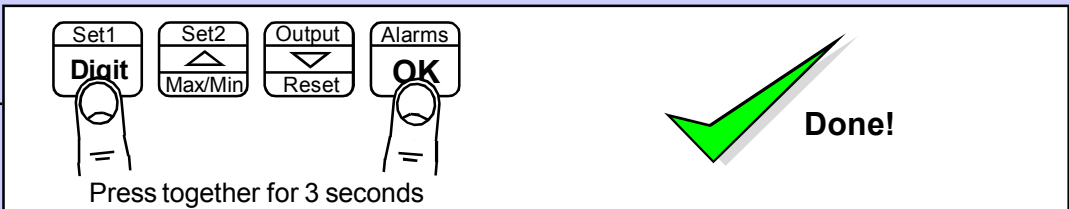
**1** — **Done!**

# Signal Filtering / Averaging

You can adjust the filtering time constant to reduce the effect of noise or instability on your input signal.

A larger FIL value will give a more stable display, but the response to signal changes will be slower.

Because your output options, such as analogue output, alarm relays and serial output are all derived from the displayed value, they will respond at the same rate as the filtered display.

**This feature is available in Easy and Advanced Modes**

- 1** Lockout Switch must be OFF  
Press 3 seconds  
Circuit board ON
- 2** Display shows **F IL.XX.X** where **XX.X** is the time constant in seconds. Use the UP or DOWN button to increase or decrease this value (Default = **F IL.00.0**)
- 3** Done!  
Press to accept

See also Filter Jump setting in the Advanced Menu, if your signal is particularly noisy and you cannot get sufficient smoothing with this filter.

# Filter Jump value

See the Easy/Advanced mode selection page near the beginning of this manual, and choose advanced mode.

The Filter Jump value allows you to decide how the display will respond to a process step change. It does this by overriding the filtering, if the input signal moves by more than a chosen amount in one conversion. The Filter Jump default value is 10%.

This means that for noise amplitude which has a peak value of less than 10% of the input range, filtering will be applied. Any signal movement greater than 10% of the input range will cause the display to jump immediately to that value, without filtering. After that jump, normal filtering will be re-applied, provided signal movement thereafter is less than 10% per conversion.

## Guidance:

For noisy systems, increase the Filter Jump value up to a maximum of 99. Choose a value which gives a good compromise between filtering and response speed.

For reasonably clean signals, a Filter Jump value of around 10 or less will give a good compromise between filtering and response speed to step change inputs.

**!! This feature is available in Advanced Mode only !!**

1

Set1 Digit	Set2 ▲ Min	Output ▼ Set	Alarms OK
---------------	------------------	--------------------	--------------

Press 3 seconds

**Lockout Switch must be OFF**

OFF  
  
ON

Circuit board

2

Set1 Digit	Set2 ▲ Max/Min	Output ▼ Reset	Alarms OK
---------------	----------------------	----------------------	--------------

Press repeatedly until you see **F L.J.XX** where **XX** is the Filter Jump percentage  
(Default = **F L.J.09**)

3

Set1 Digit	Set2 ▲ Max/Min	Output ▼ Reset	Alarms OK
---------------	----------------------	----------------------	--------------

You can set from **00** to **99**. Use the DIGIT and UP or DOWN button to increase or decrease this value.

4

Set1 Digit	Set2 ▲ Max/Min	Output ▼ Reset	Alarms OK
---------------	----------------------	----------------------	--------------

Press repeatedly to accept and return to display

**Done!**

# Last Digit rounding up by 1, 2, 5, 10, 20 or 50

You can adjust the way the display rounds up, which is useful if you want to display a very large number, but do not want jitter on the last digit.

The display can be set to round up to the nearest 1 (no rounding) 2, 5, 10, 20 or 50

**This feature is available in Easy and Advanced Modes**

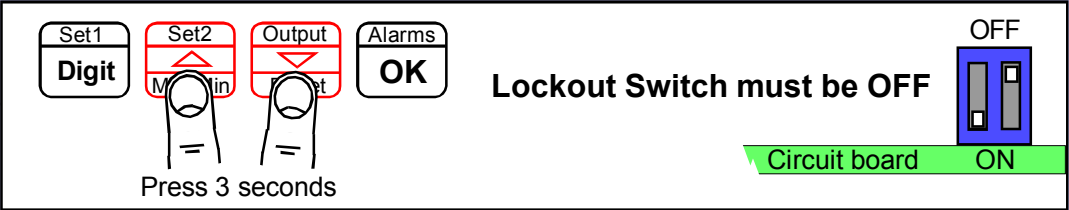
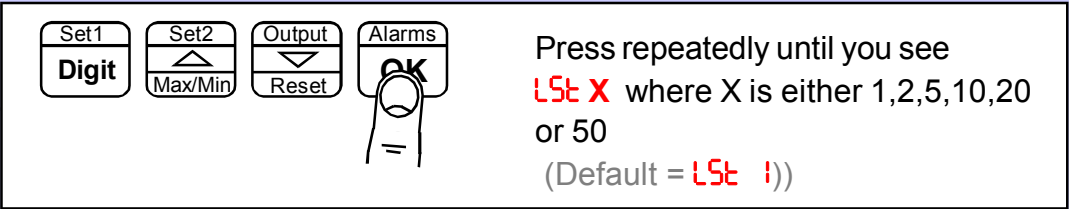
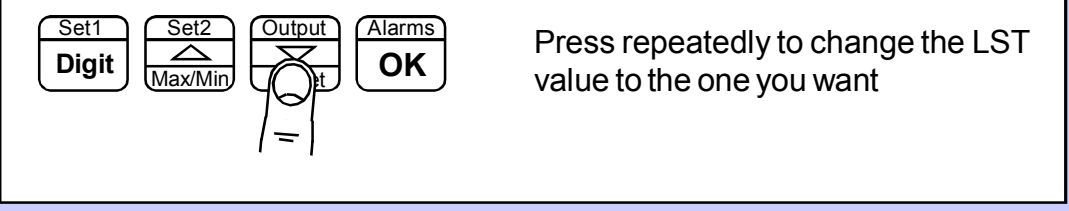
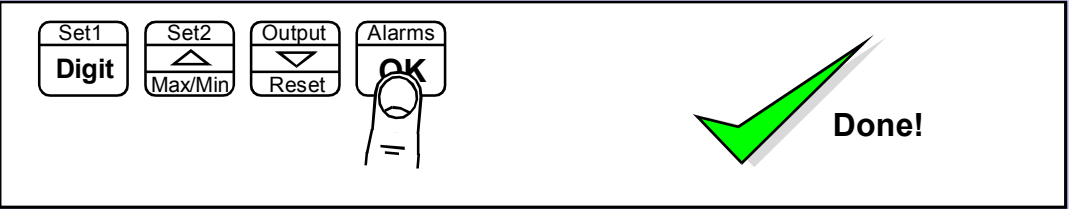
- 1** — 
- 2** — 
- 3** — 
- 4** — 



# Scale Factor adjustment

After you have calibrated your meter, you can use the SCALE feature to make fine adjustments to calibration, without affecting the calibration itself.

## Examples

### 1. Changing weight units of measure from kg to pounds

You could also use the SCALE to convert your readout from kg to pounds, without affecting the calibration. Simply set SCALE = 2.205 and your meter which was calibrated in kg will now read in pounds.

### 2. Correcting for gravitational variance

Your weighing system was calibrated where gravitational acceleration =  $9.812\text{m/s}^2$  (London) You then move the system to Bangkok where gravitational acceleration is reduced to  $9.782\text{m/s}^2$

You can correct for this difference by setting Scale =  $9.812 / 9.782 = 1.003$ , so that a given mass in Bangkok will show the same weight as it did in London. Set Offset = 0.0000

See [http://en.wikipedia.org/wiki/Earth%27s\\_gravity](http://en.wikipedia.org/wiki/Earth%27s_gravity)

**!! This feature is available in Advanced Mode only !!**

- 1

Set1	Set2	Output	Alarms
Digit	Max/Min	Reset	OK

Press 3 seconds

**Lockout Switch must be OFF**

Circuit board

OFF

ON
- 2

Set1	Set2	Output	Alarms
Digit	Max/Min	Reset	OK

Press repeatedly until you see **SCALE**, followed by the existing scale factor. (Default = **00 1.000**)
- 3

Set1	Set2	Output	Alarms
Digit	Max/Min	Reset	OK

Use DIGIT button to select each digit in turn, UP or DOWN buttons to increase or decrease each digit's value. Press OK when done.
- 4

Set1	Set2	Output	Alarms
Digit	Max/Min	Reset	OK

Press to accept

**Done!**

You may want to adjust an offset value also, see separate OFFSET page for this feature.

# Offset adjustment

After you have calibrated your meter, you can use the **OFFSET** feature to make fine additions or subtractions to the reading, without affecting the calibration itself.

For example if your weighing structure is altered after calibration and you want to subtract the effect of 37kg of extra metalwork which was welded to the hopper, you can easily do this by entering a value of -37 in the offset value.

**!! This feature is available in Advanced Mode only !!**

**1**

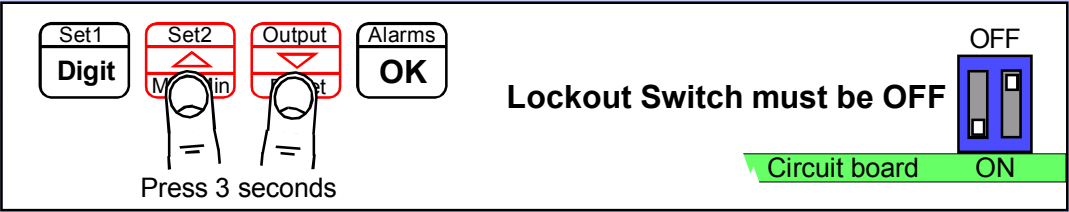

Press 3 seconds

**Lockout Switch must be OFF**

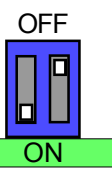

Circuit board ON

**2**

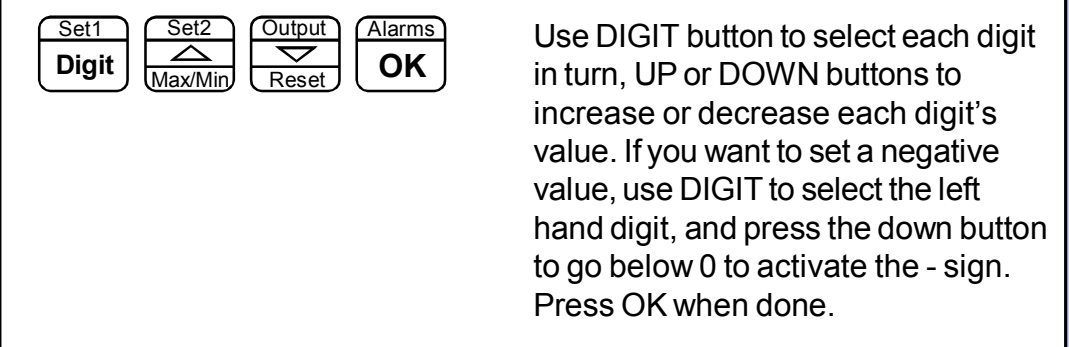

Press repeatedly until you see **OFFSEt**, followed by the existing offset value. (Default is **000.000**)

Press repeatedly until you see **OFFSEt**, followed by the existing offset value. (Default is **000.000**)

**3**

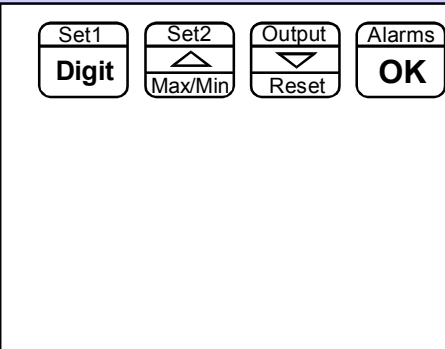

Use DIGIT button to select each digit in turn, UP or DOWN buttons to increase or decrease each digit's value. If you want to set a negative value, use DIGIT to select the left hand digit, and press the down button to go below 0 to activate the - sign. Press OK when done.

Use DIGIT button to select each digit in turn, UP or DOWN buttons to increase or decrease each digit's value. If you want to set a negative value, use DIGIT to select the left hand digit, and press the down button to go below 0 to activate the - sign. Press OK when done.

**4**

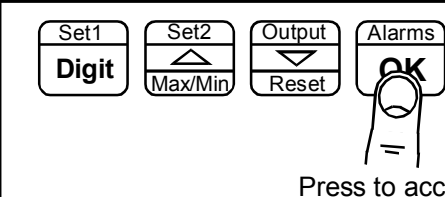

Press to accept

 **Done!**

You may want to adjust a SCALE FACTOR value also, without affecting calibration. See the separate SCALE page for this feature.

# Menu timeout adjustment

The display has a default timeout of 60 seconds, to allow you sufficient time to refer to the manual between key operations.

You can make this period shorter, if you wish, once you become more familiar with the setup method.

**!! This feature is available in Advanced Mode only !!**

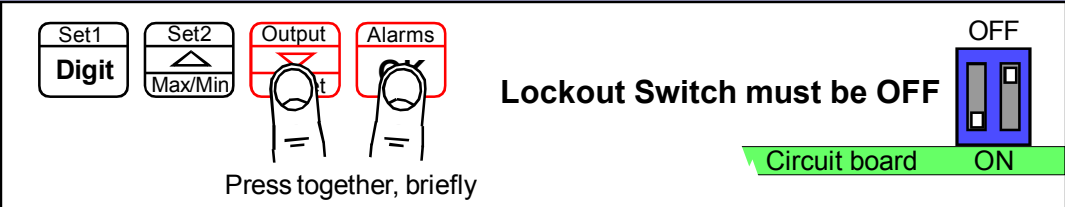
- 

1 — Press together, briefly

Lockout Switch must be OFF

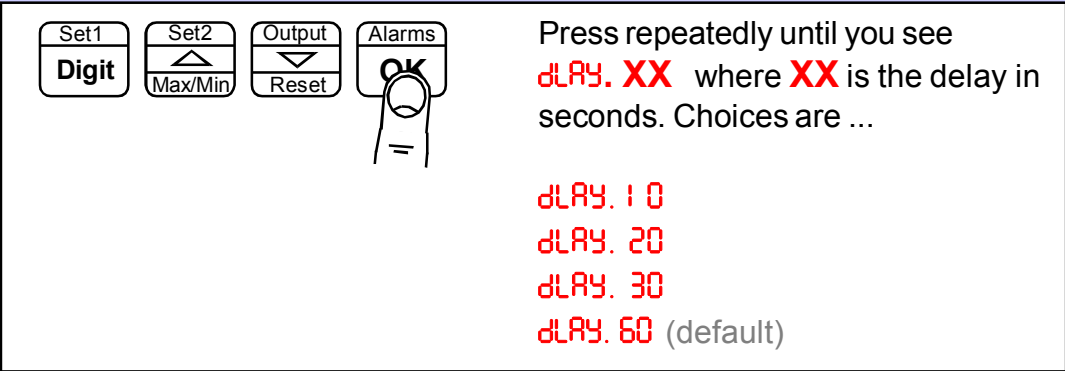
Circuit board ON
- 

2 — Press repeatedly until you see **dLAY. XX** where **XX** is the delay in seconds. Choices are ...

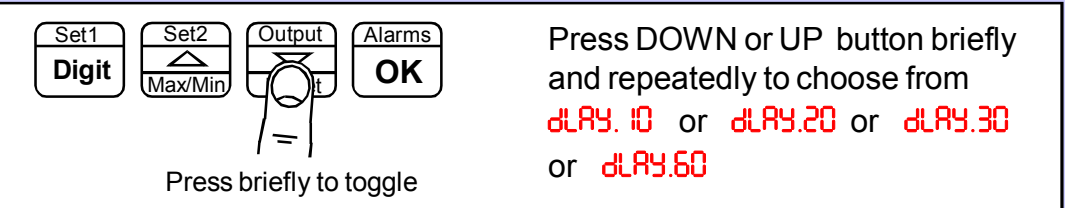
**dLAY. 10**  
**dLAY. 20**  
**dLAY. 30**  
**dLAY. 60** (default)
- 

3 — Press DOWN or UP button briefly and repeatedly to choose from **dLAY. 10** or **dLAY. 20** or **dLAY. 30** or **dLAY. 60**

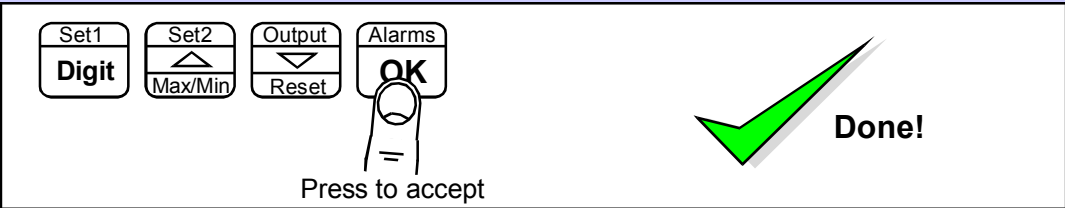
Press briefly to toggle
- 

4 — Press to accept

Done!

# Reverse Display function (mirror image)

If you need to be able to see a reflection of the display in a mirror or other reflective surface, for example in a simple heads-up system, or for drivers reversing into a bay, using mirrors only, you can set the display to show as a mirror image.

**!! This feature is available in Advanced Mode only !!**

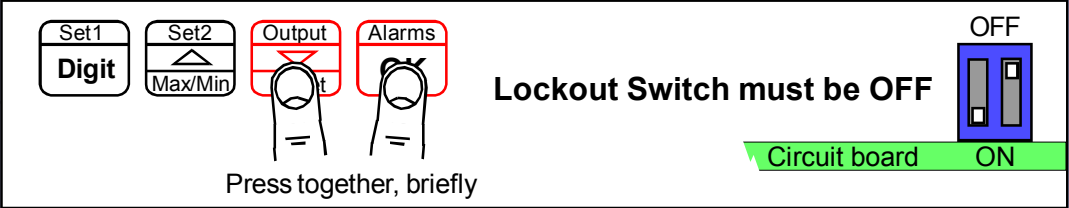
- 

Lockout Switch must be OFF

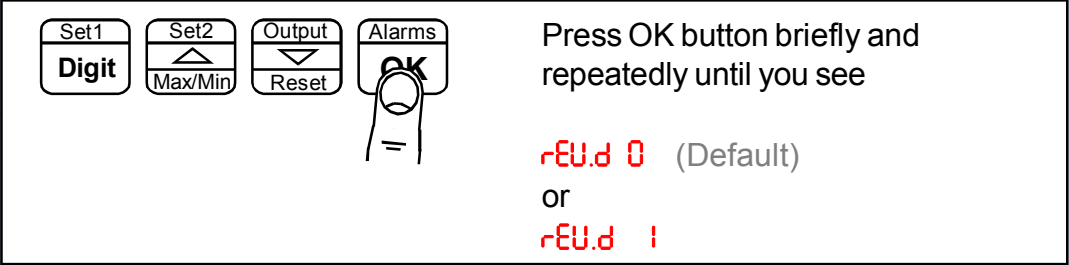
Press together, briefly
- 

Press OK button briefly and repeatedly until you see

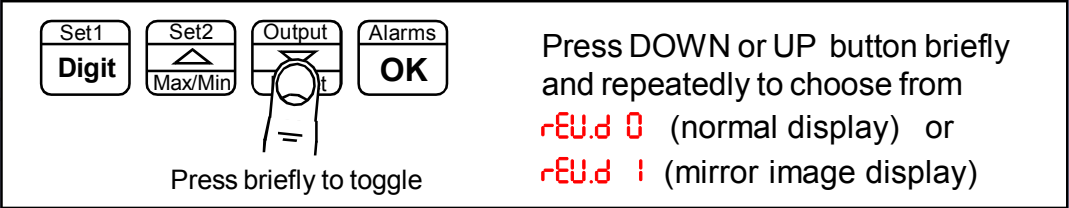
rEU.d 0 (Default)  
or  
rEU.d 1
- 

Press DOWN or UP button briefly and repeatedly to choose from

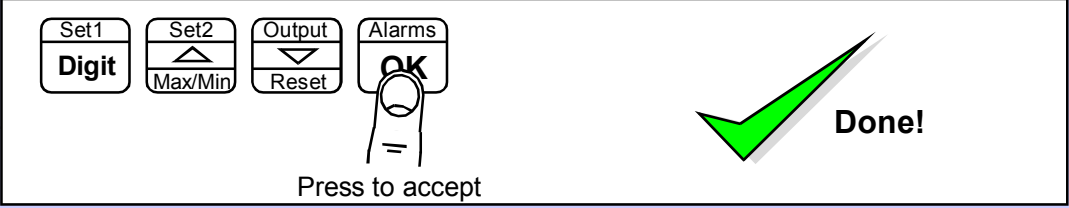
rEU.d 0 (normal display) or  
rEU.d 1 (mirror image display)
- 

Press to accept

Done!



Example of normal display format displaying the number 876543



Example of Mirror Reverse display format displaying the number 876543





# Bootup routine choices

When you switch on your meter, it can be set to power up with 3 possible summary message combinations.

The choices are:-

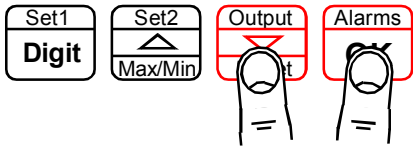
- boot 0** = Segment test, followed by a full summary of software revision, calibration audit number, model number, installed options.
- boot 1** = Segment test followed by model number (Default)
- boot 2** = No summary, meter displays the measurement value immediately power is applied.

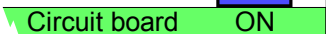
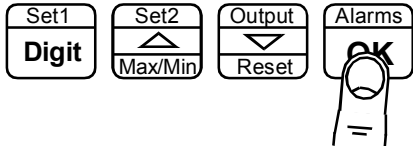
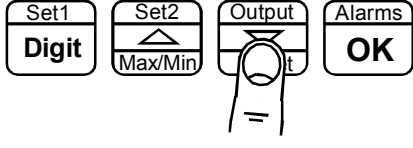
**!! This feature is available in Advanced Mode only !!**

- 1**  **Lockout Switch must be OFF**   
Circuit board ON   
Press together, briefly
- 2**  Press OK button briefly and repeatedly until you see **boot 0** or **boot 1** or **boot 2** displayed.
- 3**  Press DOWN or UP button briefly and repeatedly to choose from **boot 0** or , **boot 1** or **boot 2**  
Press briefly to toggle
- 4**   **Done!**  
Press to accept



You can trigger the full summary message whenever you want, without having to power the meter off, by pressing and holding the 2 outer buttons (Set1 + Alarms) for more than 3 seconds.

# Multi-Program Memory option MEM

The three contact closure inputs on the rear of the meter may be used to call up between 1 to 7 additional meter setup memories (pages), if the MEM option has been installed. This allows you to save up to 8 complete sets of independent calibrations, alarm settings, analogue output settings and serial comms settings.

First decide how many memory pages you want, as this will determine how many logic inputs you will need to use for the addressing. Logic inputs not required for Page Addressing can be used for other functions such as Tare, Reset, Display Hold, Peak/Valley display.

If you have used all 3 logic inputs for Page Addressing, you can still use the meter's front panel buttons to perform Tare, Reset and peak/Valley view.

**See "Contact Closure Input Functions" page for CC.1, CC.2, CC.3 and COP settings**

Total number of pages	Logic Inputs required for addressing
1	none, standard single page meter
2	1 Set CC.1 = PA.1
3 or 4	2 Set CC.1 = PA.1, Set CC.2 = PA.2
5 to 8	3 Set CC.1 = PA.1, Set CC.2 = PA.2, Set CC.3 = PA.4

1. Set lockout switches OFF, and set page address to 0 or unplug the logic connector.
2. Set the copy instruction to **COP. 1** in page address 0 ( found after you set CC3) .
3. Press all 4 buttons together, display shows **dEFS. n**
4. Press the Up arrow to change display to **dEFS. y** and press OK.
5. If you want all channels to share a common setting, eg calibration, do that setting now.
6. When you want to do separate settings for each channel, set COP.0

## Programming and recalling individual pages

Plug the logic input connector back in, if you removed it earlier. Select a page address using the switch combinations shown below, wired to the Logic Input connector ...

Page address 0	All logic inputs open
Page address 1	CC.1 closed to Common
Page address 2	CC.2 closed to Common
Page address 3	CC.1 and CC.2 closed to Common
Page address 4	CC.4 closed to Common
Page address 5	CC.1 and CC.3 closed to Common
Page address 6	CC.2 and CC.3 closed to Common
Page address 7	All logic inputs closed to Common

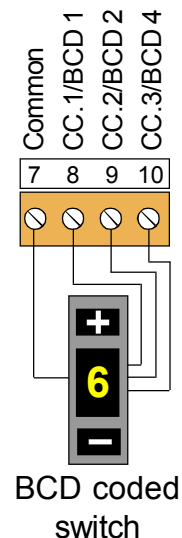

Perform the settings you require, according to the pages in this manual. Do this for all page addresses required. Then put the lockout switch in its ON position. Now, if you select a page address, the meter will briefly confirm the chosen page address on screen, and will then function according to the settings you programmed for that address.

Suitable BCD coded switches are available from many electrical supply stores. For example consider Kraus & Naimer part A540-600 E24 or Apem part number IRBC10N1248 or London Electronics part number SW2P-8W-BCD, which also provides separate 2 pole 8 way signal selection function.

# Error codes and fault finding



1. Under Range. The meter is being asked to display a value which is more negative than its limit of -199999



2. Over Range. The meter is being asked to display a value which is higher than its limit of 999999

These fault codes could be displayed because the signal is too negative, too positive, or because there is a wiring error, or because the display's scaling has been adjusted to give excessive sensitivity, or because there is a fault in the display.

Please check the signal wiring and signal levels.

b. If the measurements above were satisfactory, the problem may be caused by the scaling being too sensitive.

If you are happy to do so, it is a simple matter to reset the display's scaling to the factory default conditions. Put the lockout switch off and press all 4 buttons together for around 3 seconds until the display shows "dEFS n". Then press the UP button once so the display shows "dEFS Y". Now press the OK button and the display will be reset to factory defaults.

If still no success, please return the display to us for the attention of our QA Manager, with a report of what you found, for repair.

# How to install option boards



Where the product is intended for "UL" installations removal or addition of option boards is not permitted.



**Warning:** Disconnect power before you expose the rear of the meter

If you want to open your meter to install or modify option boards, follow these steps...

- 1) Switch off power to the meter and unplug all connectors.
- 2) Unclip the front bezel. This is easier if you squeeze the top and bottom of the case, near the front.
- 3) Remove the small screws shown in the diagram. If the meter doesn't yet have an output option board, the top screw may not yet be fitted.
- 4) Slide the electronic boards out through the front of the case. You can easily separate the upper option board from the main board. We strongly suggest that you use anti-static precautions to prevent damage to the semiconductors.

The board assemblies will look something like this...

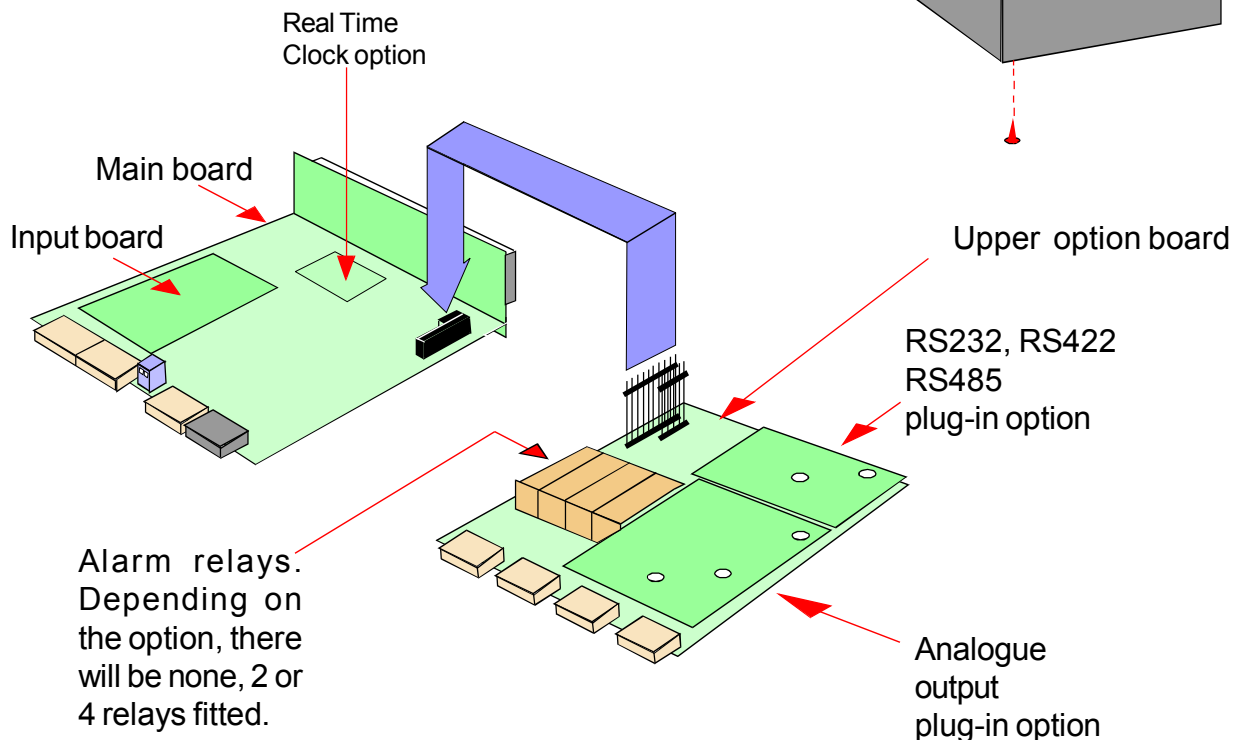

The analogue output and RS232 or RS422 plug-in option boards are fixed to the upper option board with white plastic pillars. You must apply a firm force when fitting or removing these options.

Always be careful to connect the pins to sockets accurately. When reassembling, make sure option boards are firmly fixed to the upper option board. When the boards are replaced in the case, secure them again with the two small black screws.



# Waste Electrical Electronic Equipment (WEEE)

In Europe, this equipment must be disposed of in accordance with European Parliamentary Directive 2002/96/EC

This directive encourages recycling and the reduction of waste materials in the environment.

This means it must be sent to an approved recycling plant if you want to dispose of it.

It must not be thrown away with general rubbish.



# WEEE Waste Recycling

If you are unable to dispose of this item locally, you may send it to us for recycling.

## Conditions:

1. We will only accept items of our manufacture.
2. You must pay for the transport of the goods to us.
3. We will only accept items if they include a signed declaration by an authorised person in your organisation, stating that :-
  - i. The item is safe to handle and has no contaminants which may be harmful to health.
  - ii. You wish us to dispose of or destroy the item(s)

# Equipment Specifications

<b>Bezel size</b>	48mm high by 96 mm wide (1/8 DIN)
<b>Panel Cutout</b>	45 mm high by 92 mm wide
<b>Case Depth</b>	125 mm including connectors
<b>Weight</b>	300 grammes
<b>Case Material</b>	Black polycarbonate
<b>Connectors</b>	Detachable Screw Terminal connectors
<b>Environmental</b>	Storage Temperature range -20 to +70C, non condensing Operating temperature range 0 to 50C, non condensing Front sealed IP65. Optional cover SPC4 for IP67
<b>Power Burden</b>	100-240 VAC, 45 to 60Hz or 11-30 VDC optional 10VA maximum
<b>Input Signals (bipolar)</b>	2 x 0-10V
<b>Input Resistance</b>	1 Megohm
<b>Accuracy</b>	+/-0.05% of range
<b>Span tempco</b>	25 ppm/Degree Celsius
<b>Zero Tempco</b>	30 ppm/Degree Celsius
<b>24V Excitation voltage</b>	24VDC nominal rated at 60mA
<b>10V Excitation voltage</b>	10VDC nominal rated at 20mA
<b>Filtering / smoothing</b>	Selectable time constants of 0 to 25 seconds.
<b>A/D conversion</b>	Sigma-Delta 10 conversions per second, 50/60Hz rejection Resolution 1 in 400 000 max. over full range
<b>Display update rate</b>	10 readings per second.
<b>Display Range (max)</b>	-199999 to +199999, depending on available signal level.

## Plug-In Output Options

<b>Analogue O/P</b>	See analogue output manual for details. Available from <a href="http://www.london-electronics.com/manuals/">http://www.london-electronics.com/manuals/</a>
<b>Alarm Relay O/P</b>	See alarm output manual for details. Available from <a href="http://www.london-electronics.com/manuals/">http://www.london-electronics.com/manuals/</a>
<b>ASCII Data O/P</b>	See Serial output manual for details. Available from <a href="http://www.london-electronics.com/manuals/">http://www.london-electronics.com/manuals/</a>
<b>Calendar/Clock option</b>	See serial output manual for details. Available from <a href="http://www.london-electronics.com/manuals/">http://www.london-electronics.com/manuals/</a>

# Record of Revisions

6 September 2010

Version F0.18 Software released. Manual format revised to improve clarity and segregate easy from advanced menu functions. Optional outputs now described in their own dedicated manuals. DIN Rail mounting option added. Cabling guidance added.

# Declaration of CE Conformity

Declaration Reference : INTUITIVE Mk2  
Issue Date : 30 April 2007  
Products Covered : INTUITIVE Mk2 series  
Title : DOC-INTUITIVE2

This is to confirm that the Product covered by this declaration has been designed and manufactured to meet the limits of the following EMC Standard :

**EN61326-1:1997**

and has been designed to meet the applicable sections of the following safety standards

**EN61010-1:2001**



## Conditions

The meters are permitted a worst case error of 1% of A/D range during electro-magnetic disturbance, and must recover automatically when disturbance ceases without the need for human intervention, such as resetting, power-down etc.

The meters covered by this certificate must be installed in adherence to the following conditions :-

Signal cabling shall be routed separately to power carrying cabling (includes relay output wiring)

All signal cabling shall be screened. The screen shall only be terminated to the power earth terminal at the meter end of the cable.

Declared as true and correct, for and on behalf of London Electronics Ltd.

J.R.Lees Director